



SOUND LEVEL ASSESSMENT REPORT

South Coast Renewables, LLC New Bedford, Massachusetts

Prepared for:

***South Coast Renewables, LLC
(FKA: Parallel Products of New England, Inc.)
100 Duchaine Boulevard
New Bedford, Massachusetts 02745***

Prepared by:



***Epsilon Associates, Inc.
3 Mill & Main Place, Suite 250
Maynard, MA 01754***

February 12, 2024

TABLE OF CONTENTS

1.0	INTRODUCTION	1-1
2.0	PROJECT UPDATE	2-1
3.0	PROJECT DESCRIPTION	3-1
4.0	SOUND TERMINOLOGY	4-1
5.0	NOISE REGULATIONS	5-1
5.1	Federal Regulations	5-1
5.2	Massachusetts State Regulations	5-1
5.3	Local Regulations	5-1
6.0	EXISTING SOUND LEVELS	6-1
6.1	Overview	6-1
6.2	Baseline Sound Environment	6-1
6.3	Sound Level Measurement Locations	6-1
6.3.1	Monitoring Locations	6-1
6.4	Measurement Methodology	6-4
6.5	Measurement Equipment	6-4
6.5.1	Sound Level Equipment	6-4
6.5.2	Meteorological Equipment	6-4
6.6	Baseline Ambient Sound Levels	6-4
6.7	Establishment of Background Sound Levels	6-5
7.0	MODELED SOURCE SOUND LEVELS AND MITIGATION	7-1
7.1	Continuous Noise Sources	7-1
7.2	Incidental Noise Sources	7-3
7.3	Mitigation – Barrier Walls	7-6
8.0	SOUND MODELING METHODOLOGY	8-1
9.0	SOUND MODELING RESULTS	9-1
10.0	EVALUATION OF SOUND LEVELS	10-1
10.1	Continuous Sources	10-1
10.2	Incidental Sources	10-1
10.3	Pure Tone Analysis	10-5
11.0	BEST AVAILABLE CONTROL TECHNOLOGY	11-1
11.1	BACT Guidance	11-1
11.2	BACT Approach	11-2
11.3	Source-by-Source BACT Measures	11-3
11.3.1	Continuous Noise Sources	11-3

11.3.2	Intermittent Noise Sources	11-4
11.3.3	Other Facility Noise.	11-6
11.4	Facility-Wide BACT Measures	11-6
12.0	CONCLUSIONS	12-1

LIST OF FIGURES

Figure 3-1	Aerial Locus	3-3
Figure 4-1	Common Indoor and Outdoor Sound Level	4-3
Figure 6-1	Sound Level Measurement Locations	6-3
Figure 6-2	Baseline Monitoring Graphical Results – ML East1	6-7
Figure 6-3	Baseline Monitoring Graphical Results – ML East2	6-8
Figure 6-4	Baseline Monitoring Graphical Results – ML South	6-9
Figure 6-5	Baseline Monitoring Graphical Results – ML West	6-10
Figure 6-6	Baseline Monitoring Graphical Results – ML North	6-11
Figure 7-1	Sound Level Modeling and Sound Source Locations	7-7
Figure 9-1	Continuous Source Modeling Results – Daytime	9-2
Figure 9-2	Continuous Source Modeling Results – Nighttime	9-3

LIST OF TABLES

Table 6-1	Sound Level Measurement Location Coordinates.....	6-2
Table 6-2	Hourly Minimum L ₉₀ Across Monitoring Period at Measurement Locations	6-5
Table 7-1	Continuous Source Sound Power Levels per Noise Source	7-2
Table 7-2	Continuous Source Pre-Attenuation Octave Band Sound Power Levels per Noise Source	7-3
Table 7-3	Continuous Source Octave Band Noise Attenuation Levels	7-3
Table 7-4	Incidental Source Sound Power Levels per Noise Source	7-5
Table 9-1	Modeled Unmitigated and Mitigated Sound Levels for Continuous Sources.....	9-1
Table 9-2	Modeled Sound Levels for Incidental Plus Continuous Daytime Sources	9-1
Table 10-1	Modeled Continuous Sound Pressure Levels Compared to Ambient.....	10-1
Table 10-2	Modeled Sound Pressure Levels Compared to Ambient for Continuous Sources Plus Backup Alarm (6 am to 7 pm)	10-2
Table 10-3	Modeled Sound Pressure Levels Compared to Ambient for Continuous Sources Plus Idling Locomotive (7 am to 7 pm).....	10-2
Table 10-4	Modeled Sound Pressure Levels Compared to Ambient for Continuous Sources Plus Railcar Coupling (6 am to 7 pm).....	10-3

Table 10-5 Modeled Sound Pressure Levels Compared to Ambient for Continuous Sources Plus Truck Inbound and Outbound Operations (6 am to 7 pm)²10-3

Table 10-6 Modeled Sound Pressure Levels Compared to Ambient for Continuous Sources Plus Street Sweeper Operations (10 am to 4 pm).....10-3

Table 10-7 Modeled Sound Pressure Levels Compared to Ambient for Continuous Sources Plus Railcar Pusher (6 am to 7 pm).....10-4

Table 10-8 Modeled Sound Pressure Levels Compared to Ambient for Continuous Sources Plus Moving Locomotive with Railcars (6 am to 7 pm)10-4

Table 10-9 Modeled Sound Pressure Levels Compared to Ambient for Continuous Sources Plus Open Railcar Bay Door (6 am to 7 pm)10-4

Table 10-10 Modeled Sound Levels Compared to Ambient for Continuous Sources Plus Backup Alarm and Truck Inbound and Outbound Operations (6 am to 7 pm)10-5

1.0 INTRODUCTION

Noise assessments for this project have been presented within the historical Executive Office of Energy and Environmental Affairs MEPA filings including the Draft Environmental Impact Report [DEIR] (November 2019), the Final Environmental Impact Report [FEIR] (January 2021), the Supplemental Final Environmental Impact Report [SFEIR] (July 2022), and the Site Suitability Application [SSA] (February 2023). There were modifications to the site plan after submittal of the FEIR, including the removal of the biosolids building and associated sound sources (both stationary and mobile). Previous reports have addressed continuous operating sources of sound such as rooftop HVAC equipment, loading/tipping operations, and building exhaust stacks, as well as incidental sources such as noise from truck traffic, railcar coupling, and locomotive idling.

This revised assessment documents the noise sources and mitigation associated with the current site plan and addresses comments made by the Massachusetts Department of Environmental Protection (MassDEP) during the SSA review by collecting new ambient data and further evaluating incidental and mobile sources to include additional activities. This assessment shows that the impacts from all sounds due to the development of the proposed Project will be mitigated to the maximum extent practical and will not cause a nuisance noise condition or noise pollution and the property lines as well as off-site receptors.

2.0 PROJECT UPDATE

The MassDEP has requested additional evaluation of noise sources associated with the Project. In response to the MassDEP comments, this revised assessment includes the results of an expanded ambient sound level measurement program. The assessment also includes evaluation of additional short-term incidental noise sources from the Project including more rail movement activities and street sweeping, and documents that South Coast Renewables, LLC (SCR) has mitigated Project generated sound to the maximum extent practical.

This report provides a description of the applicable noise policy requirements, a brief explanation of noise terminology, a summary of the results of an ambient sound level monitoring program, a discussion of the sound level modeling analysis for the continuous sources of the proposed Project, a discussion of the sound level modeling analysis for the short-term incidental sound sources from the Project, and a review of the top-down best available control technology (BACT) evaluation process. Noise control options are discussed in order to meet the requirements of the MassDEP Noise Policy at all property lines, and to avoid, minimize, and mitigate noise impacts.

3.0 PROJECT DESCRIPTION

SCR is currently operating a glass handling and processing facility at 100 Duchaine Boulevard in New Bedford, Massachusetts. SCR is proposing to construct a solid waste processing and handling facility at this site. The project will be implemented in sequential phases. The glass handling was implemented as Phase 1 and was not part of the Site Suitability application. The solid waste processing and handling operations will be implemented as Phase 2 and is subject to Site Suitability and Site Assignment under 310 CMR 16.00. This sound level evaluation is cumulative and addresses both new and existing sound sources associated with the Project and proposed future operations.

The glass handling operation will recycle the used glass containers that are collected through the Massachusetts deposit system. Bottles collected will be processed such that the glass can be reused to produce new glass containers. Processing at the site will include crushing, sizing, and separation of the glass by color. The cullet produced is then sold to glass manufacturers. To facilitate the shipment of recycled glass by rail, the Proponent will construct a rail sidetrack from the existing rail line adjacent to the project site. Glass handling operations are enclosed by three adjacent buildings.

A new solid waste processing and handling building will be constructed at the site, with a capacity to accept up to 1,500 tons per day of solid waste (MSW and C&D) delivered to the facility by truck. The tipping building is expected to be approximately 65,000 square feet in floor area and will connect with an existing 103,000 SF building. Approximately 50,000 square feet of the existing building will be used to house the solid waste processing equipment. The remainder will be used to handle recyclables that are not considered solid waste and are already appropriately permitted under 310 CMR 16.000. The tipping building will be designed to allow waste delivery trucks to enter into the building to tip their loads of waste material for subsequent processing/handling and outbound loading for delivery to off-site disposal outlets. The facility will accept both baled MSW and MSW delivered loose in transfer trailers and packer trucks. Baled MSW will be delivered to the proposed facility from other transfer stations that have baled MSW to meet the railroad requirements for shipping MSW in rail cars. Baled MSW accepted at the proposed facility will be loaded into rail cars for shipment to disposal sites such as a landfill or waste to energy facility. The facility will also accept C&D defined as Category 2 (C&D processing residuals). All MSW will follow CSX approved standards with respect to the shipment of waste (e.g. baled, intermodal, or other approved method). As deemed appropriate, front-end loaders will load the unbaled MSW into a feed hopper that sends the MSW through a series of processing equipment. The existing building will be modified as required to house the MSW processing equipment used to extract recyclable material from MSW received. It is expected, based on market conditions, that approximately 20% of the MSW processed will be reclaimed and recycled.

Previously, the ENF, DEIR and FEIR discussed plans to construct a biosolids processing facility as part of Phase 2. As discussed in the SFEIR, addition of a biosolids facility is no longer being proposed.

The following describes the building ventilation, process equipment and other notable equipment associated with the Project that were included in the continuous sources sound study.

- Rooftop, ground level, and/or sidewall inlet and exhaust fans on MSW Building and Glass Processing Building;
- Baghouse exhaust stack
- Front-end loaders or excavators and tipping operations inside open garage door bays of MSW Building (management of inbound materials associated with truck deliveries)
- Front-end loader or excavator operations inside closed garage door bay of MSW Building (railcar loadout operations)

The following describes the equipment associated with the Project that were included as short-term incidental sources sound study. Additional detail is provided in Section 7.2:

- Backup alarms
- Idling locomotive
- Railcar coupling
- Trucks associated with deliveries of solid waste
- Street sweeper operations
- Electric railcar pusher
- Moving locomotive with railcars
- Open rail bay door

Operations at the proposed facility will vary between daytime when waste delivery is taking place (6 am to 7 pm) and nighttime when the facility is not accepting deliveries (7 pm to 6 am). Sound level modeling was conducted for both a daytime scenario and a nighttime scenario and compared to both daytime and nighttime ambient sound levels. Mitigation was applied to several of the sound sources including fan silencers, low noise fans, stack silencer(s), and use of an electric rail car mover. A system of sound barriers has also been added to mitigate sound from the tipping area at the uninhabited property line to the west, and the industrial property lines to the north and south. This is discussed further below. With the noise mitigation measures described in this report, or equivalent design changes, the proposed Project will meet the requirements set forth in the MassDEP Noise Policy at all property lines and will mitigate Project-generated sound to the maximum extent practical.

It should be noted that the facility could use other forms of mitigation to meet the MassDEP Noise Policy sound limits and these options may be further refined once SCR has fully designed the facility. As such, the mitigation shown herein is presented to demonstrate that the facility can be compliant, but other forms of mitigation can be assessed and incorporated in the final design (e.g. during the Authorization to Construct phase under 310 CMR 19.000).

An aerial locus of the project site over aerial imagery is shown in Figure 3-1

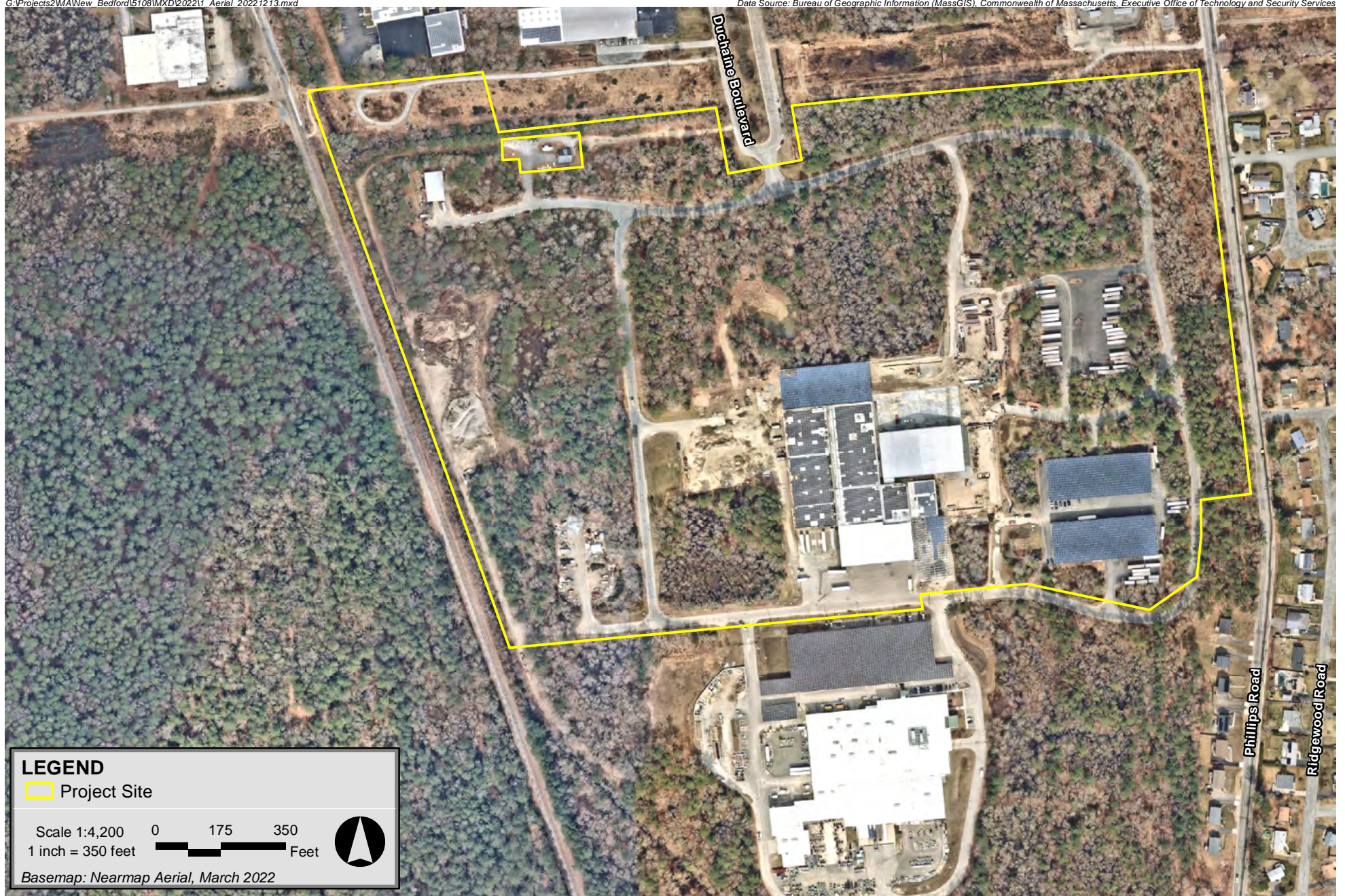

South Coast Renewables New Bedford, Massachusetts

4.0 SOUND TERMINOLOGY

There are several ways in which sound levels are measured and quantified. All of them use the logarithmic decibel (dB) scale. The following information defines the sound level terminology used in this analysis.

The decibel scale is logarithmic to accommodate the wide range of sound intensities found in the environment. A property of the decibel scale is that the sound pressure levels of two or more separate sounds are not directly additive. For example, if a sound of 50 dB is added to another sound of 50 dB, the total is only a 3-decibel increase (53 dB), which is equal to doubling in sound energy but not equal to a doubling in decibel quantity (100 dB). Thus, every 3-dB change in sound level represents a doubling or halving of sound energy. A 3-dB increase or decrease corresponds to the threshold of perceptibility of change. In practice, a 3 dBA change in environmental sound is at the margin of perceptibility to the average person.¹

Another mathematical property of decibels is that if one source of sound is at least 10 dB louder than another source, then the total sound level is simply the sound level of the higher-level source. For example, a sound source at 60 dB plus another sound source at 47 dB is equal to 60 dB.

A sound level meter (SLM) that is used to measure sound is a standardized instrument.² It contains “weighting networks” (e.g., A-, C-, Z-weightings) to adjust the frequency response of the instrument. Frequencies, reported in Hertz (Hz), are detailed characterizations of sounds, often addressed in musical terms as “pitch” or “tone”. The most commonly used weighting network is the A-weighting because it most closely approximates how the human ear responds to sound at various frequencies. The A-weighting network is the accepted scale used for community sound level measurements; therefore, sounds are frequently reported as detected with a sound level meter using this weighting. A-weighted sound levels emphasize middle frequency sounds (i.e., middle pitched – around 1,000 Hz), and de-emphasize low and high frequency sounds. These sound levels are reported in decibels designated as “dBA”. Z-weighted sound levels are measured sound levels without any weighting curve and are otherwise referred to as “unweighted”. Sound pressure levels for some common indoor and outdoor environments are shown in Figure 4-1.

Because the sounds in our environment vary with time they cannot simply be described with a single number. Two methods are used for describing variable sounds. These are exceedance levels and the equivalent level, both of which are derived from a large number of moment-to-moment A-weighted sound level measurements. Exceedance levels are values from the cumulative amplitude distribution of all of the sound levels observed during a measurement period. Exceedance levels are designated Ln, where n can

¹ 2009 ASHRAE Handbook – Fundamentals, American Society of Heating, Refrigeration, and Air-Conditioning Engineers, Inc., Atlanta, GA.

² *American National Standard Specification for Sound Level Meters*, ANSI S1.4-1983 (R2006), published by the Standards Secretariat of the Acoustical Society of America, Melville, NY.

have a value between 0 and 100 in terms of percentage. Three sound level metrics that are utilized in this report are described below.

- L_{90} is the sound level exceeded 90 percent of the time during the measurement period. The L_{90} is close to the lowest sound level observed. It is essentially the same as the residual sound level, which is the sound level observed when there are no obvious nearby intermittent sound sources. The L_{90} level is used to establish the “ambient” or “background” sound level as part of the MassDEP Noise Policy.
- L_{eq} , the equivalent level, is the level of a hypothetical steady sound that would have the same energy (*i.e.*, the same time-averaged mean square sound pressure) as the actual fluctuating sound observed. The equivalent level is designated L_{eq} and is typically A-weighted. The equivalent level represents the time average of the fluctuating sound pressure, but because sound is represented on a logarithmic scale and the averaging is done with linear mean square sound pressure values, the L_{eq} is mostly determined by loud sounds if there are fluctuating sound levels.

Sound Pressure Level, dBA

COMMON INDOOR SOUNDS **COMMON OUTDOOR SOUNDS**

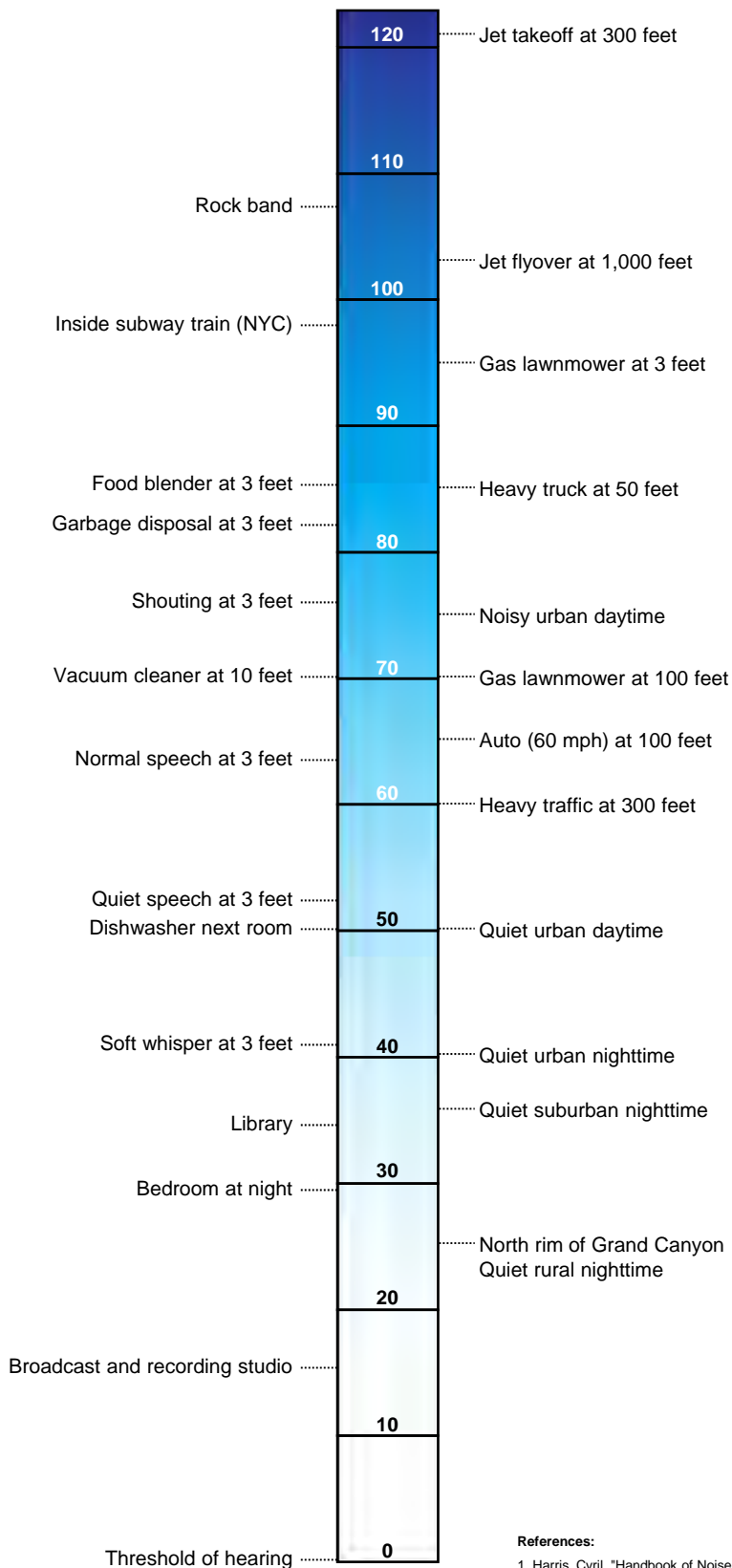

References:

- Harris, Cyril, "Handbook of Noise Acoustical Measurements and Noise Control", p 1-10., 1998
- "Controlling Noise", USAF, AFMC, AFDT, Elgin AFB, Fact Sheet, August 1996
- California Dept. of Trans., "Technical Noise Supplement", Oct, 1998

5.0 NOISE REGULATIONS

5.1 Federal Regulations

There are no federal noise regulations applicable to this Project.

5.2 Massachusetts State Regulations

The Massachusetts Department of Environmental Protection (MassDEP) has the authority to regulate noise under 310 CMR 7.10, which is part of the Commonwealth's air pollution control regulations. Under MassDEP regulations, noise is considered to be an air contaminant and, thus, 310 CMR 7.10 prohibits "unnecessary emissions" of noise.

The MassDEP administers this regulation through its Noise Policy DAQC 90-001, dated February 1, 1990. The Noise Policy limits a source to a 10-dBA increase above the ambient sound measured (the L₉₀ sound level) at the property line for the site and at the nearest residences.

MassDEP's Noise Policy further prohibits "pure tone" conditions where the sound pressure level in one octave band is 3 dB or more than the sound levels in each of the two adjacent octave bands. A qualitative example of a source emitting a "pure tone" is a fan with a bad bearing that is producing an objectionable squealing sound.

5.3 Local Regulations

There are no local quantitative noise regulations applicable to this Project.

6.0 EXISTING SOUND LEVELS

6.1 Overview

The Project site is located at 100 Duchaine Boulevard in New Bedford, Massachusetts. The property is bordered by residential neighborhoods to the northeast, east and southeast. The property is bordered by industrial/commercial properties to the north and south, and by Massachusetts Department of Conservation and Recreation (DCR) land (Acushnet Cedar Swamp) to the west. An active rail line runs parallel to the west property line just outside the site boundary. The site currently consists of multiple industrial buildings, several surface parking lots, and solar arrays.

6.2 Baseline Sound Environment

A sound level survey was conducted in November and December 2023 to characterize the existing “baseline” acoustical environment in the vicinity of the site. The measurement locations and protocol were approved by MassDEP, who were consulted prior to deployment. Five long-term continuous sound level monitoring stations were deployed for 7-days to:

1. Establish representative A-weighted broadband ambient sound pressure levels, for evaluating requirements of the MassDEP policy; and to
2. Establish representative octave-band ambient sound pressure levels to identify any existing “pure tones,” as defined by MassDEP, and evaluate whether the addition of modeled sound levels from the proposed Project to these background sound levels may introduce or exacerbate existing “pure tones” in the community.

Only measurement periods during, or affected by, precipitation were excluded from the analysis. This approach is consistent with ANSI Standard S12.18-1994 (R2009).

6.3 Sound Level Measurement Locations

Five sound level measurement locations (MLs) were selected and approved by MassDEP to characterize the existing ambient levels in the Project Area. All five of these locations are shown over aerial imagery of the Project area in Figure 6-1 and are described below.

6.3.1 Monitoring Locations

The selection of the sound monitoring locations was intended to be representative of the existing sound levels at the Project property line. The coordinates for the five sound monitoring locations were obtained by Epsilon staff using a handheld GIS navigator and are presented in Table 6-1.

- ML East1 is located at the east property line on the west side of Phillips Rd. near the intersection with Birchwood Dr. This location is representative of the residences east and northeast of Phillips Rd.

- ML East2 is located at the east property line on the west side of Phillips Rd. just south of the intersection with Pine Hill Dr. This location is representative of the residences east and southeast of Phillips Rd.
- ML South is located along the south property line, south of the existing facility loading docks and north of the Eversource property. This location is representative of the industrial receptors south of the facility.
- ML West is located at the west property line of the facility adjacent to railroad tracks and the Acushnet Cedar Swamp State Reservation. This location is representative of the uninhabited conservation land located west of the facility.
- ML North is located west of Duchaine Blvd. near the north facility property line. This location is representative of the industrial receptors north of the facility.

Table 6-1 Sound Level Measurement Location Coordinates

Location	Coordinates	
	UTM NAD83 Zone 19N, Meters	
	Easting	Northing
ML East1	245928.81	829902.80
ML East2	245956.55	829659.10
ML South	245570.29	829559.83
ML West	245314.17	829661.86
ML North	245511.67	829945.88

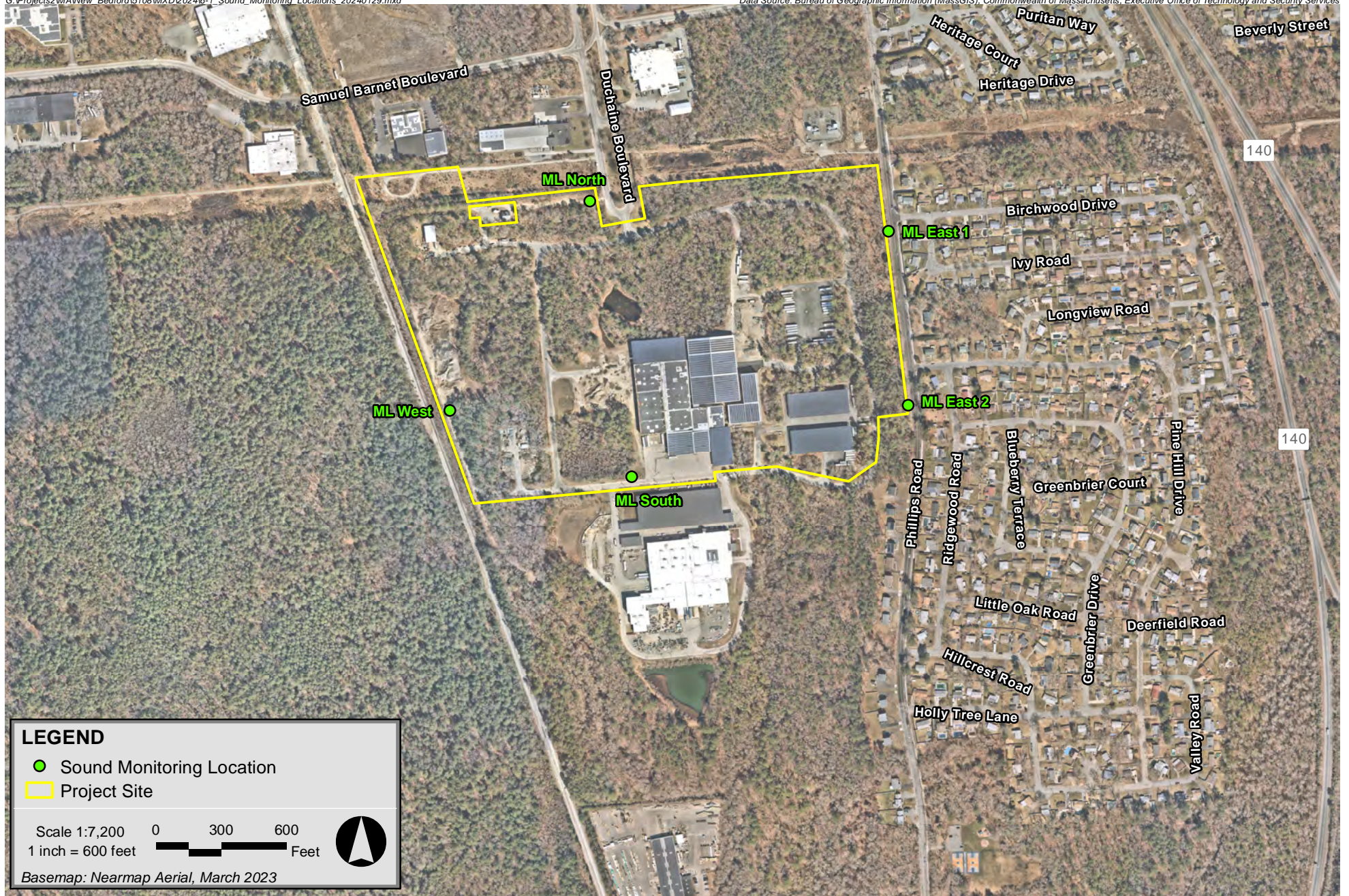

South Coast Renewables New Bedford, Massachusetts

6.4 Measurement Methodology

A comprehensive sound level measurement program was developed to quantify the ambient sound levels around the Project. Continuous A-weighted and octave-band measurements (24 hours/day) were made over approximately a one-week period from Thursday, November 30, 2023, through Thursday, December 7, 2023.

Ground-level wind speeds and precipitation can have a significant impact on measured sound levels. Wind speed and precipitation measurements were made at a height of approximately 2 meters above ground level with an ATMOS weather station that was placed near ML South. Measurement periods with precipitation or wind speeds exceeding 11.2 mph (5 m/s) were excluded from the analysis. All sound and meteorological data collected during the program are included in the ambient analysis.

6.5 Measurement Equipment

6.5.1 Sound Level Equipment

Five Larson Davis model 831 sound level meters equipped with PCB Piezotronics Type 1 preamplifiers, PCB 377B20 or 377C20 half-inch microphones, and environmental protection kits were used to collect continuous hourly broadband and octave-band sound pressure level data.

All meters meet Type 1 ANSI S1.4-1983 (R2006) standards for sound level meters and were calibrated and certified as accurate to standards set by the National Institute of Standards and Technology. These calibrations were conducted by an independent laboratory within the prior 12 months of the measurement program. Additionally, all sound level measurement equipment was calibrated in the field before and after the surveys with the manufacturer's acoustical calibrator which meets the standards of IEC 942 Class 1L and ANSI/ASA S1.40-2006 (R2016).

6.5.2 Meteorological Equipment

An ATMOS 41 (manufactured by The Meter Group) was used to continuously measure the wind speed, wind direction, and any local precipitation at ML South. The wind sensor was mounted at a height of approximately six feet above ground level and data were logged hourly to be synced with the sound level measurements. The ATMOS 41 sensor has a measurement range of 0 to 30 m/s (67 mph) and an accuracy of ± 0.3 m/s (0.7 mph).

6.6 Baseline Ambient Sound Levels

The ambient sound level environment consists primarily of nearby vehicle traffic from Phillips Road, traffic on Route 140 and other local roadways, activity at nearby industrial facilities during the daytime, rustling vegetation, aircraft, rail line activity and birds.

Long-term sound levels were measured continuously from Thursday, November 30, 2023 through Thursday, December 7, 2023. A summary of the measurement results is presented herein.

Continuous 1-hour sampling periods with a one-minute time history were measured. Hourly A-weighted broadband sound pressure level data from the continuous ambient monitors are presented in Figures 6-2 through 6-6. Periods of precipitation totaling 36 hours as recorded by the ATMOS weather station, were excluded from the dataset. These precipitation periods are shown in Figures 6-2 through 6-6.

6.7 Establishment of Background Sound Levels

To accurately represent the data when activities at the Facility could have time restrictions, the hourly ambient data were processed to allow for ease of comparison to Project related sound levels. For each hour (i.e. the 1 AM hour being from 1:00 AM to 1:59 AM), the lowest valid hourly L_{90} sound level across all 7 days was determined. The hourly data were based on the broadband (dBA) background sound levels described above. The lowest hourly L_{90} data that were used to evaluate the Project and requirements of the MassDEP Noise Policy are presented in Table 6-2 below.

At the request of MassDEP, the lowest measured hourly L_{90} level over the course of the week-long measurement program was used to quantify the ambient sound level in the project area. This results in nighttime ambient sound levels ranging from 31 to 34 dBA at the measurement locations. The lowest daytime L_{90} sound level between 6 am and 7 pm when tipping (e.g. waste delivery) will be taking place ranged from 33 to 39 dBA at the measurement locations. These values were used as the point of comparison and subsequent modeling for project noise. Using the single lowest hour over the seven day monitoring period to quantify the ambient sound level is highly conservative, as existing sound levels in the area are typically higher than those used in the analysis.

Table 6-2 Hourly Minimum L_{90} Across Monitoring Period at Measurement Locations

Hour Start	Hour End	Lowest Hourly L_{90} Ambient (dBA)				
		East 1	East 2	South	West	North
12:00 AM	12:59 AM	34	32	34	33	36
1:00 AM	1:59 AM	34	33	35	34	36
2:00 AM	2:59 AM	34	33	35	35	36
3:00 AM	3:59 AM	35	36	35	34	37
4:00 AM	4:59 AM	34	34	33	31	33
5:00 AM	5:59 AM	36	36	34	32	35
6:00 AM	6:59 AM	39	39	36	35	37
7:00 AM	7:59 AM	44	43	39	35	38
8:00 AM	8:59 AM	43	42	37	34	37
9:00 AM	9:59 AM	43	42	37	34	37
10:00 AM	10:59 AM	45	43	37	35	37
11:00 AM	11:59 AM	48	44	38	35	39
12:00 PM	12:59 PM	48	42	37	34	37
1:00 PM	1:59 PM	47	43	38	33	37
2:00 PM	2:59 PM	45	43	38	34	38
3:00 PM	3:59 PM	46	44	38	35	39
4:00 PM	4:59 PM	49	47	40	39	43
5:00 PM	5:59 PM	46	45	40	38	42

Hour Start	Hour End	Lowest Hourly L ₉₀ Ambient (dBA)				
		East 1	East 2	South	West	North
6:00 PM	6:59 PM	45	44	41	36	41
7:00 PM	7:59 PM	43	42	39	37	40
8:00 PM	8:59 PM	41	39	37	36	40
9:00 PM	9:59 PM	39	37	36	35	40
10:00 PM	10:59 PM	40	39	38	36	39
11:00 PM	11:59 PM	38	37	36	35	37

Figure 6-2
 Baseline Monitoring Graphical Results - ML East 1
 1-Hour Ambient Sound Pressure Level Data

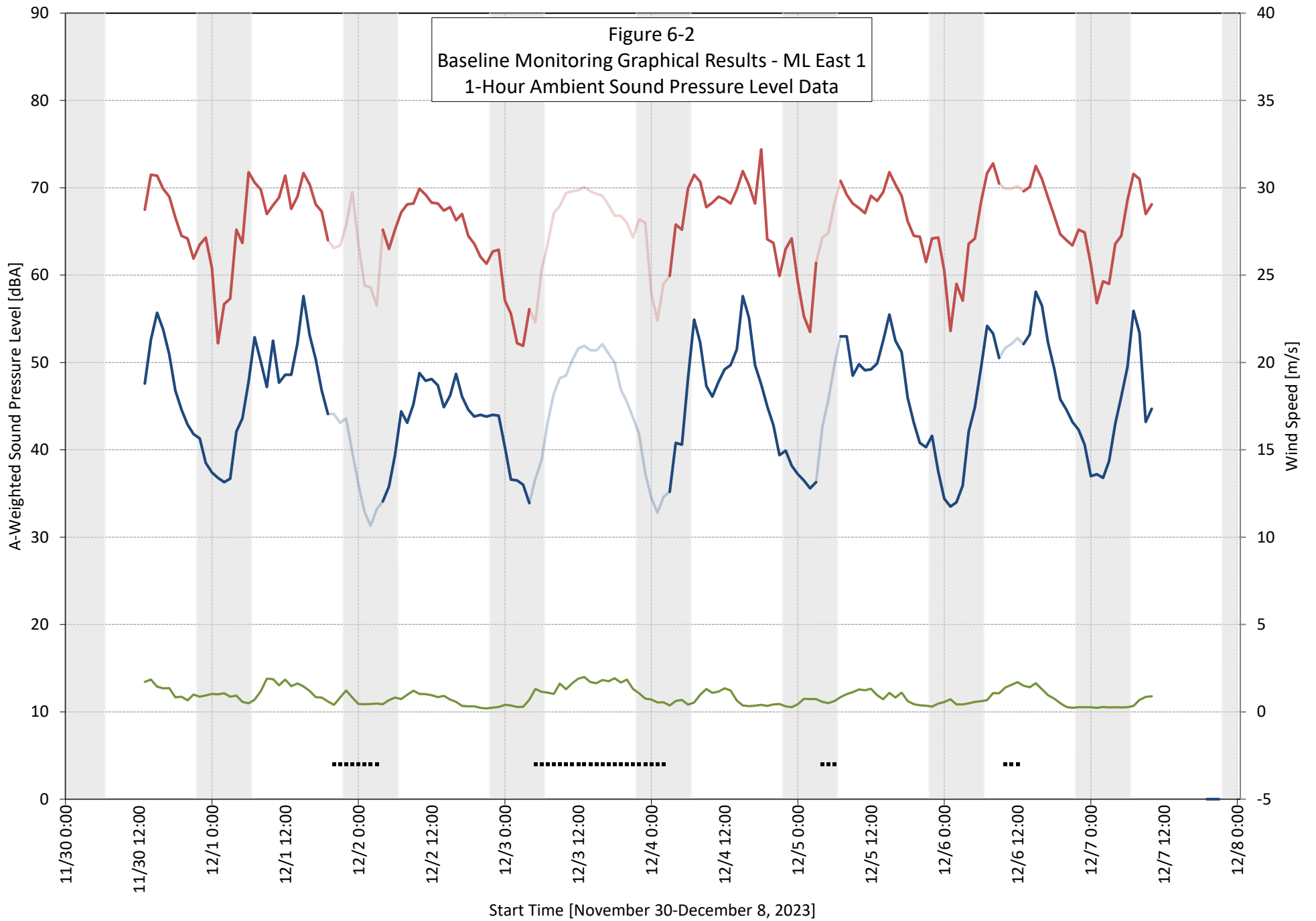

- Leq Measured
- L90 Measured
- Leq Valid
- L90 Valid
- Ground Level Wind Speed
- High Wind
- Precipitation
- Range Exceedance

Figure 6-3
 Baseline Monitoring Graphical Results - ML East2
 1-Hour Ambient Sound Pressure Level Data

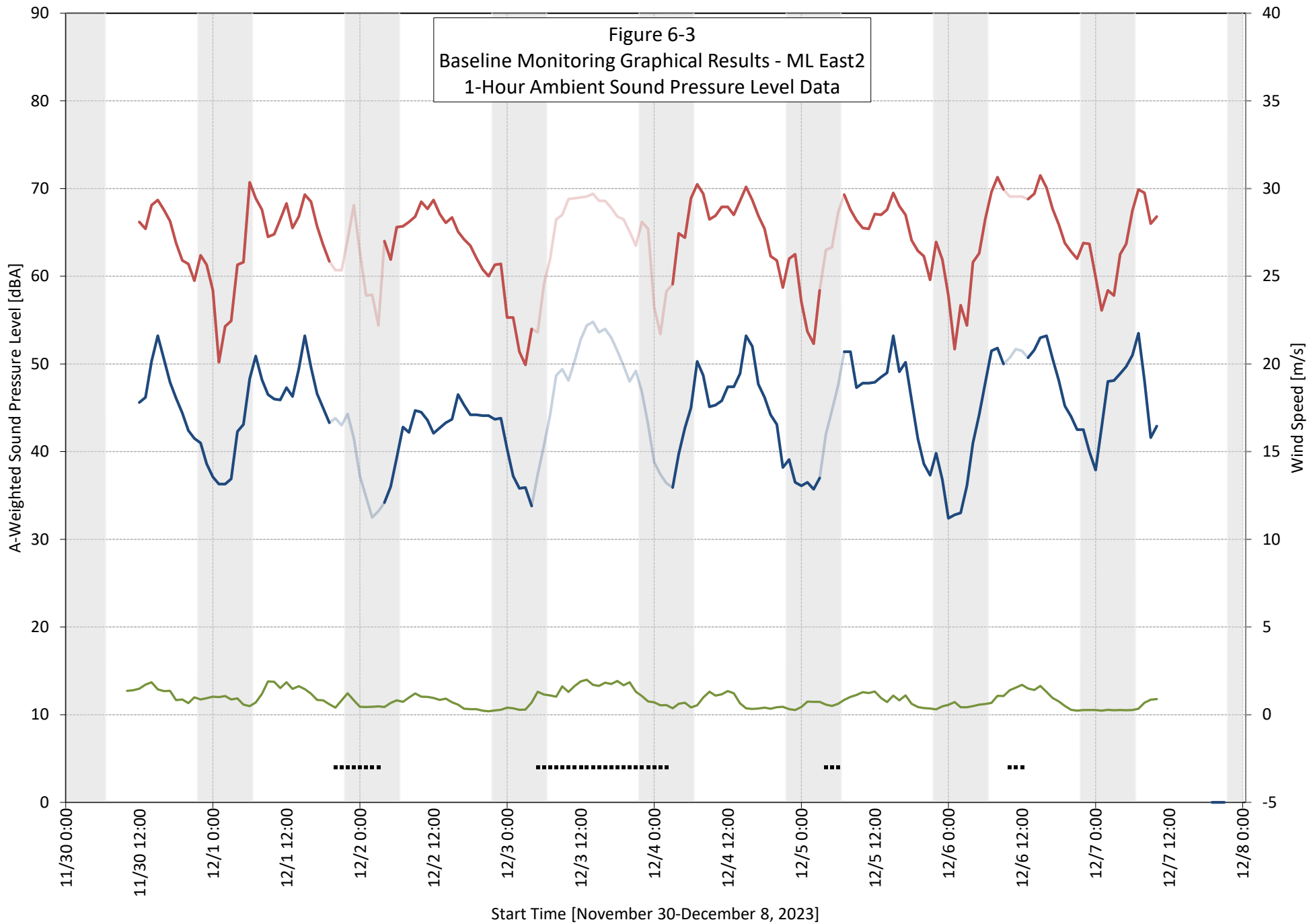

- Leq Measured
- L90 Measured
- Leq Valid
- Ground Level Wind Speed
- High Wind
- Precipitation
- Range Exceedance

Figure 6-4
 Baseline Monitoring Graphical Results - ML South
 1-Hour Ambient Sound Pressure Level Data

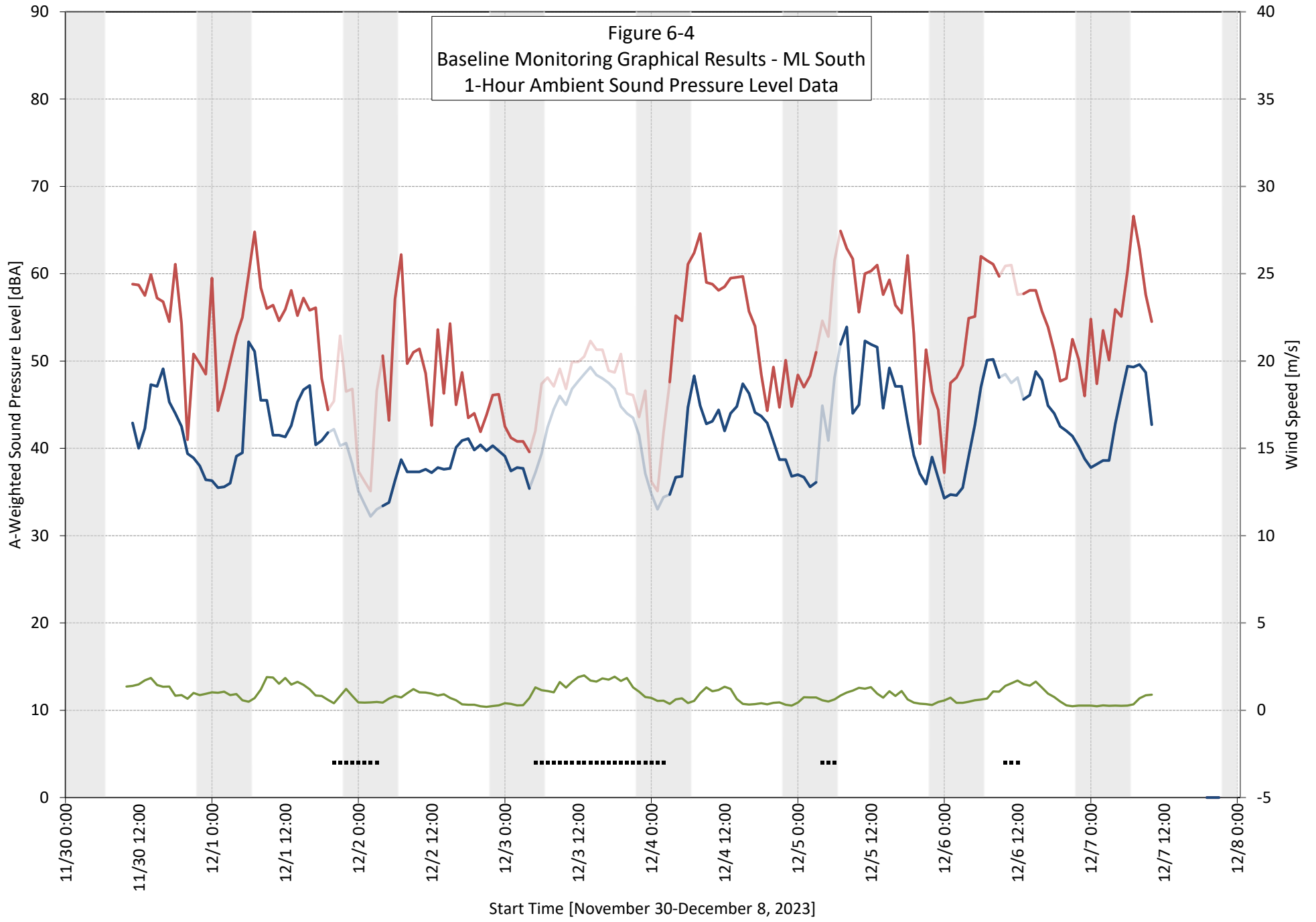

- Leq Measured
- L90 Measured
- Leq Valid
- L90 Valid
- Ground Level Wind Speed
- High Wind
- Precipitation
- Range Exceedance

Figure 6-5
 Baseline Monitoring Graphical Results - ML West
 1-Hour Ambient Sound Pressure Level Data

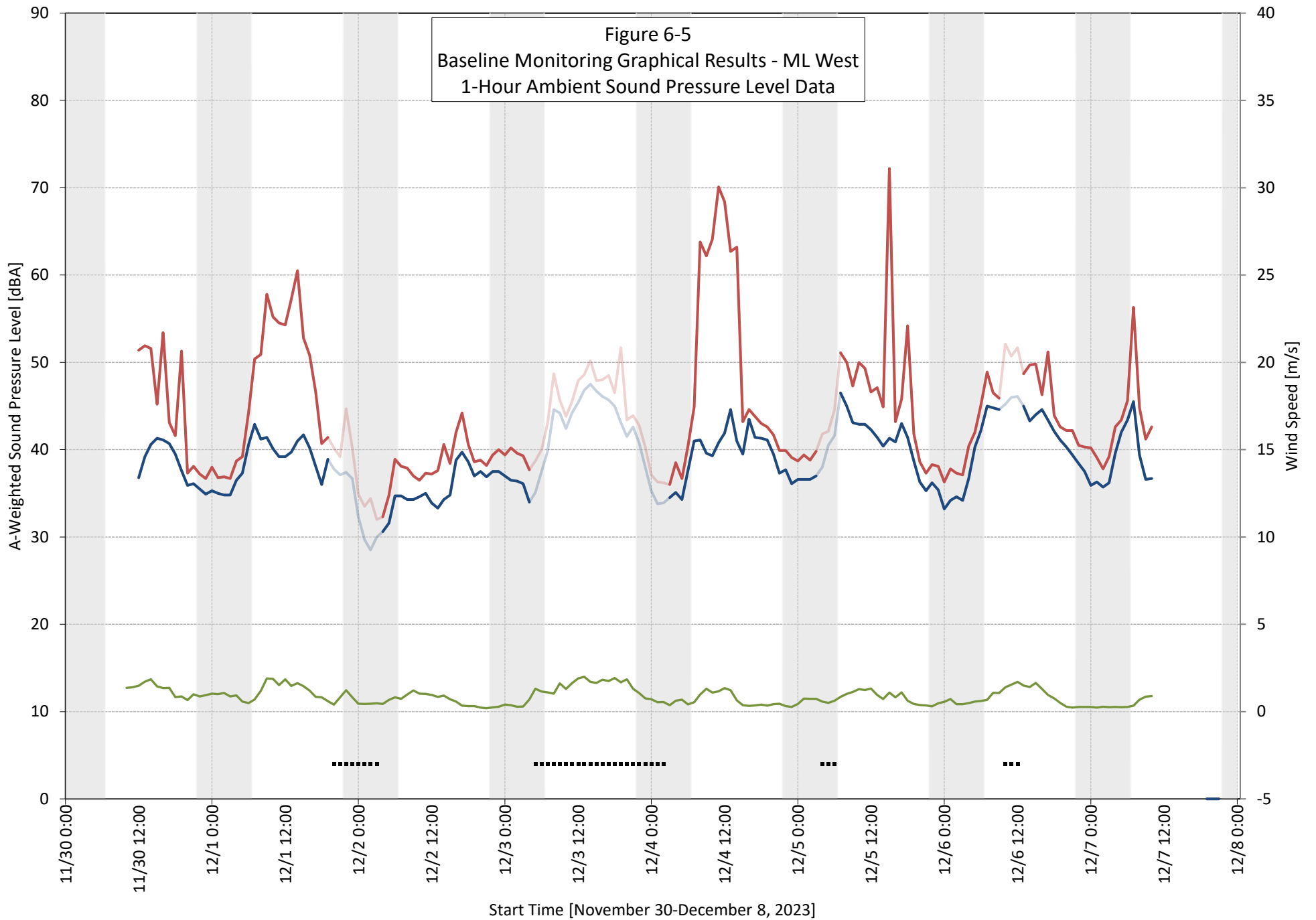

- Leq Measured
- L90 Measured
- Leq Valid
- Ground Level Wind Speed
- High Wind
- Precipitation
- Range Exceedance

Figure 6-6
 Baseline Monitoring Graphical Results - ML North
 1-Hour Ambient Sound Level Pressure Data

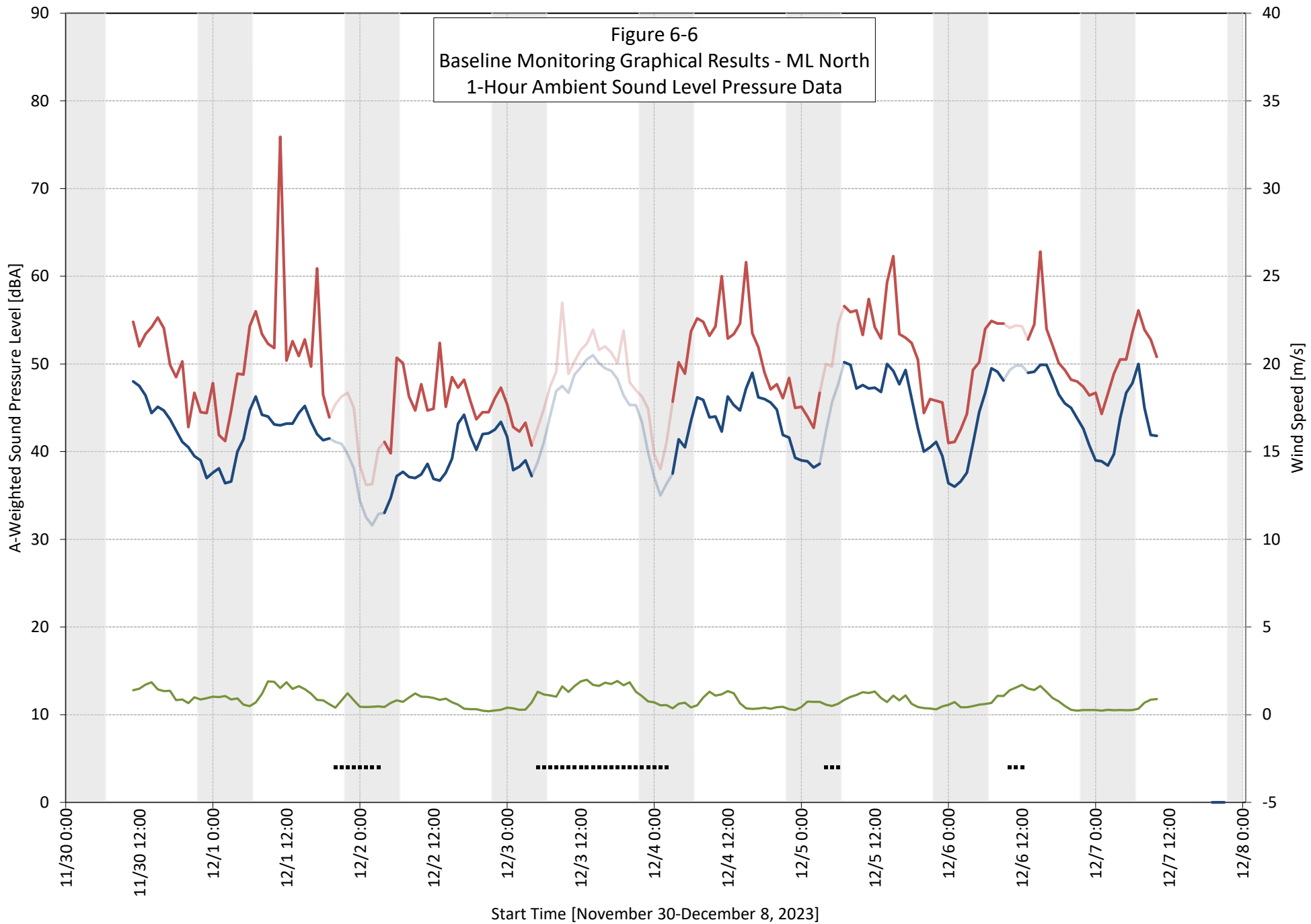

- Leq Measured
- L90 Measured
- Leq Valid
- Ground Level Wind Speed
- L90 Valid
- High Wind
- Precipitation
- Range Exceedance

7.0 MODELED SOURCE SOUND LEVELS AND MITIGATION

Modeled sources are broken into two types – continuous and incidental. Continuous sources represent the primary sources of sound from system ventilation, tipping/moving of solid waste, railcar loading, etc. Incidental noise sources represent sounds from mobile sources that do not occur continuously when the facility is operating such as backup alarms, railcar coupling, idling locomotives, and inbound and outbound trucking, etc.

At this stage of the Project, key components for the facility have been selected, however some equipment selection may be refined as the design process progresses. Reference sound level data used in the noise model include vendor data, as well as representative data from sound level measurements of a similar facility or equipment where no data are provided by the manufacturer. Data sources are documented in Appendix A.

7.1 Continuous Noise Sources

Continuous sources represent stationary sources that are operating the majority of the time that the facility is operational. Not all these sources will be operating continuously, so this is a conservative estimate of continuous site noise. The continuous sources that were input into the noise model are described individually below. The broadband model inputs associated with these sources are presented in Table 7-1 below. A more detailed breakdown of the pre-attenuation sound levels is presented in Table 7-2. The noise attenuation devices and their associated sound level reductions are presented in Table 7-3. The locations of the continuous noise sources are shown in Figure 7-1.

1. Loading Bay Doors – The model includes three open loading bays on the west side of the MSW building. These bay doors are modeled as vertical area sources to represent sound being emitted through the openings. These loading bay doors represent the sounds from indoor mobile equipment operations (MSW tipping and handling activities) that will occur inside the building. The sound levels associated with this source are based on actual measurements performed by Epsilon staff at a similar operation at another facility³. The loading bay doors will only be open during tipping hours (6 am to 7 pm) when there are tipping activities taking place. Any activity taking place inside the building outside of tipping hours will be mitigated with a 50% usage factor and closed STC-30 roll-up doors.

³The sound level measurements were performed at E.L. Harvey in Westborough, MA. These measurements captured the sound levels of multiple sources occurring simultaneously including waste truck engine revving, tipping activities, a front-end loader moving materials, and other indoor mobile and fixed equipment (e.g C&D Processing Line) equipment operations.

2. Rooftop Exhaust Fans – The model includes seven rooftop exhaust fans with four on the MSW building and three (3) on the existing glass building. Each of these fans uses sound level data obtained for representative “Cook 365UCIC Tubular Centrifugal Blower 25,000 CFM” fans.
 - a. The fans on the MSW building and glass building (7 fans in total) are equipped with 3-foot silencers to reduce the sound levels by 16 dB. These sound levels could also be achieved by using quieter fans or rooftop barriers, which will be chosen during the design phase.
3. Railcar Loading Bay – The model includes one railcar loading bay on the west side of the MSW building. This door will be closed unless railcars are moving in and out of the building. This source is modeled as a vertical area source to represent sound being emitted through the closed STC-30 roll-up door. The same sound level source data for the Loading Bay Doors was used to represent the interior building noise.
4. Baghouse Intake – One ventilation opening is included in the model on the west side of the glass building. This source represents the ventilation intake for the baghouse system on the glass building. The interior level was conservatively modeled using the interior level of the tipping building. The source is assumed to incorporate an acoustic louver of the “Noishield Louver, type LF2-24” variety which achieves a 16 dBA reduction.
5. Baghouse Exhaust – The baghouse exhaust is modeled as two fans fed into the same stack. The fan noise is attenuated by typical duct losses.

Table 7-1 Continuous Source Sound Power Levels per Noise Source

Noise Source	Broadband Sound Power Level (dBA) ¹	
	Unattenuated	Attenuated
Three open loading bays (west side of MSW Building) – 6 am to 7 pm ²	110	110
Three closed loading bays (west side of MSW Building) – 7 pm to 6 am ³	106	106
25,000 CFM Rooftop Exhaust Fans (7 total) ⁴	94	78
One closed railcar loading bay (west side of MSW Building) ³	103	103
Ventilation opening for baghouse with acoustic louver (west side of Glass Building) ⁵	110	93
Baghouse exhaust fans ⁶	99	88

Notes:

1. Sound power is a metric that describes the total sound energy produced by a source and should not be confused with sound pressure, which is the sound level that an observer/receptor hears, which is much lower. Both are expressed in decibels.
2. Data collected by Epsilon at a similar facility.
3. Interior sound level mitigated with Insulsound IPB STC-30 roll-up doors. See datasheet in Appendix A.
4. Cook 365UCIC exhaust fans. See datasheet in Appendix A.

5. The interior building level was mitigated using an IAC Noishield Louver Model LF2-24. See datasheet in Appendix A.
6. The baghouse exhaust fans had a standard duct loss reduction applied. See Table 11.3 from *Engineering Noise Control* included in Appendix A.

Table 7-2 Continuous Source Pre-Attenuation Octave Band Sound Power Levels per Noise Source

Noise Source	Sound Power Level (dB) per Octave-Band Center Frequency (Hz)									Total dBA
	31.5	63	125	250	500	1k	2k	4k	8k	
25,000 CFM Rooftop Exhaust Fans	97	97	99	94	90	90	84	75	68	94
Open Loading Bays (Truck and Rail)	107	109	107	107	105	106	102	99	95	110
Baghouse Exhaust Fan – NYB HPBC Backward-Inclined 40 inch	104	104	98	93	94	92	90	84	79	97
Baghouse Exhaust Fan – NYB HPBC Backward-Inclined 33 inch	92	92	95	87	90	88	88	89	85	95

Table 7-3 Continuous Source Octave Band Noise Attenuation Levels

Mitigation Type	Insertion Loss (dB) per Octave-Band Center Frequency (Hz)								
	31.5	63	125	250	500	1k	2k	4k	8k
Insulsound STC-30 Door ¹	-	-	22	23	24	31	44	50	-
Vibroacoustics 3' Fan Silencer ²	0	5	9	16	18	22	19	15	12
Noishield Louver LF2-24 ³	3	6	11	19	24	28	23	17	17
In-Duct Sound Power Level Reductions ⁴	0	0	0	5	10	15	20	22	25

Notes:

1. Sound transmission loss (STC) shown in Intertek test report included in Appendix A.
2. Silencer performance data provided in Appendix A.
3. IAC Louver datasheet included in Appendix A.
4. Standard in-duct sound reduction from insertion loss from Table 11.3 in *Engineering Noise Control*, provided in Appendix A.

7.2 Incidental Noise Sources

Incidental noise sources represent sounds from mobile sources that do not occur continuously when the facility is operating such as backup alarms, railcar coupling, idling locomotives, and inbound and outbound trucking. These are also known as intermittent sources. Most of these noise sources are federally

regulated by the Occupational Safety and Health Administration (OSHA) (backup alarms) and the U.S. Environmental Protection Agency (USEPA) (railcar coupling and idling and moving locomotives). Federal laws and regulations⁴ preempt state and local government regulation of these sources. In addition, truck noise must comply with the Registry of Motor Vehicles regulations relative to sound emissions. However, these sources were modeled and additional noise mitigation for these sources was evaluated at the request of MassDEP.

The incidental sources that were input into the noise model are described individually below. The model inputs associated with these sources are presented in Table 7-4 and Table 7-5 below. The location of each incidental noise source is shown in Figure 7-1.

1. Backup Alarm – Truck backup alarm operating at the west side of the MSW building where trucks are most likely to be reversing. The backup alarm sound power level was based on a sound power level and usage factor documented in the TLA Holbrook report provided in Appendix A.
2. Idling Locomotive – Idling locomotive located just north of the northeast corner of the MSW building. This is as far east as the locomotive is likely to travel as the length of the rail spur will contain railcars. The locomotive sound power level was based upon the day/night (DNL) sound level of an idling locomotive at 200 ft as documented in the TLA Holbrook report provided in Appendix A. A usage factor of 25% was included based on a maximum onsite idling time of 15 minutes in an hour.
3. Railcar Coupling – This source represents railcar coupling, assumed to be occurring at the furthest possible eastern point of the rail spur (closest to the residential area). The sound level of railcar coupling was based upon the day/night (DNL) sound level of railcar coupling at 200 ft as documented in the TLA Holbrook report provided in Appendix A. A usage factor of 5% was included in the model since coupling events will occur for fewer than 3 minutes in any hour.
4. Truck Inbound and Outbound Operations – This source represents a waste delivery truck near the entrance to the facility where the sound will have the greatest impact on residential receptors. The sound level is based on measurements taken by Epsilon at a similar facility of a passing semitruck⁵. Instances of trucks passing any given location will be brief in duration, therefore a usage factor of 25% was applied to this source, which is a very conservative estimate.

⁴ Federal law preempts state and local governments from regulating the sound of trucks making deliveries to a commercial site under the Noise Control Act of 1972 and the Surface Transportation Assistance Act of 1982. USEPA regulates railroad emissions in standards published at 40 CFR 201: Noise Emission Standards for Transportation Equipment: Interstate Rail Carriers.

⁵ Truck sound level data were collected by Epsilon of passing semi-trucks at the Johnston Distribution Center in Johnston, RI.

5. Street Sweeper Operations – This source represents the onsite street sweeper that is used intermittently to clean up any debris in the tipping area. The street sweeper sound power level and usage factor were based on data from The Federal Highway Administration’s Highway Construction Noise Handbook, Table 9.1 included in Appendix A.
6. Electric Railcar Pusher – This source represents the electric railcar pusher that will be used to move onsite railcars. The sound power level was based on a 35 kW electric motor from the Cadna SET sound level library. No usage factor was included to be conservative, but the railcar will be used infrequently in practice. The specifications for the railcar mover are provided in Appendix A.
7. Moving Locomotive with Railcars – This source represents a locomotive moving railcars onsite between the rail spur and the MSW building. The moving locomotive sound power level was based upon the day/night (DNL) sound level of a locomotive moving railcars at 200 ft as documented in the TLA Holbrook report provided in Appendix A. A usage factor of 50% was included since the railcar will be moving railcars onsite for no more than 30 minutes in an hour.
8. Open Rail Bay Door – The door in the MSW building that is used by railcars will be closed unless there is a rail delivery or pickup taking place. At all other times there will be an STC-30 door mitigating the building noise at the rail door location. The sound power level is based on the open loading bay sound power level shown in Table 7-2 with a usage factor of 25% since the rail door is not expected to be open for longer than 15-minutes in any given hour.
9. Truck and Backup Alarm – Sources 1 and 4 have been evaluated together since there is a possibility that they may occur simultaneously.

Table 7-4 Incidental Source Sound Power Levels per Noise Source

Noise Source	Usage Factor (%)	Sound Power Level (dBA)	
		Total	With Usage Factor
Backup Alarm	5	109	96
Idling Locomotive	25	107	101
Railcar Coupling	5	95	82
Truck Operations	25	99	93
Street Sweeper	10	112	102
Railcar Pusher ¹	100	78	78
Moving Locomotive	50	92	89
Open Rail Door	25	110	104

Notes:

1. The railcar pusher was modeled with no usage factor to be conservative, though in practice it will only be used for a few hours each day.

7.3 Mitigation – Barrier Walls

Sound levels due to the Project equipment near the MSW tipping area will be further mitigated with a system of 20-foot-tall sound barriers. The barriers will be absorptive on the side facing the noise sources and will reduce sound levels at the uninhabited western property line, and the northern and southern industrial property lines. The proposed barrier system is shown in Figure 7-1. As mentioned in Section 3, the facility could use other forms of mitigation to meet the MassDEP Noise Policy sound limits and these options may be further refined once SCR has fully designed the facility. As such, the sound attenuation walls depicted are presented to demonstrate that the facility can be compliant, but other forms of mitigation can be assessed and incorporated in the final design (e.g. during the Authorization to Construct phase under 310 CMR 19.000).

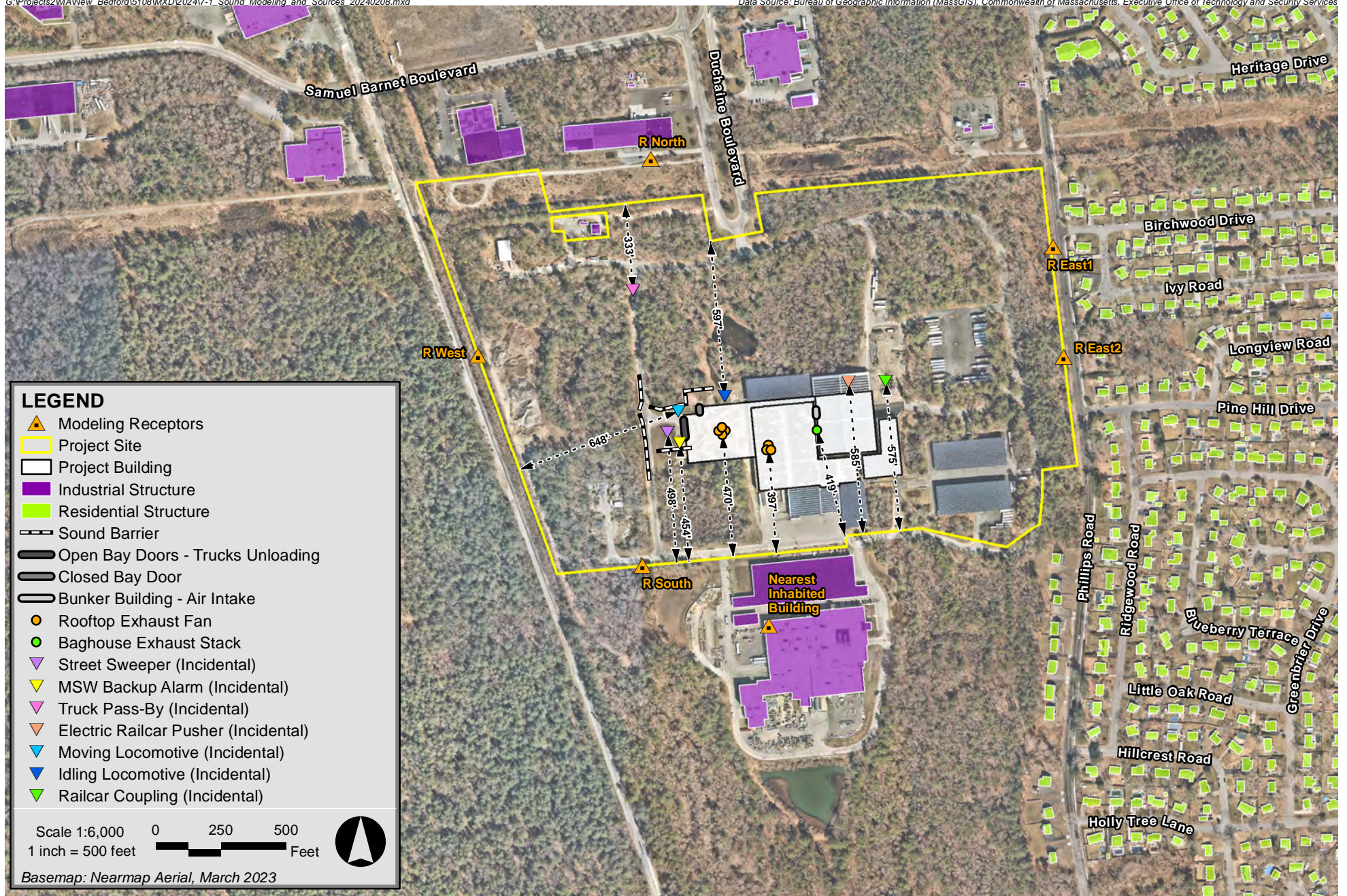

South Coast Renewables New Bedford, Massachusetts

8.0 SOUND MODELING METHODOLOGY

The noise impacts associated with the proposed Project were predicted using the CadnaA noise calculation software developed by DataKustik GmbH. This software uses the ISO 9613-2 international standard for sound propagation (Acoustics - Attenuation of sound during propagation outdoors - Part 2: General method of calculation). The benefits of this software are a refined set of computations due to the inclusion of topography, ground attenuation, multiple building reflections, drop-off with distance, and atmospheric absorption. The CadnaA software allows for octave-band calculation of sound from multiple sources as well as computation of diffraction.

Inputs and significant parameters employed in the model are described below:

- *Site Plan*: The Project Site Plan provided the locations and dimensions of key inputs into the model such as site buildings, and rail spur locations.
- *Modeling Locations*: Sound level modeling was evaluated at five property line locations that generally correspond to the sound level measurement locations shown in Figure 6-1. The modeling receptors were placed at the property line locations with the highest modeled sound level to quantify the worst-case property line sound levels. These locations are shown in Figure 7-1. All receptors were modeled with a height of 5 feet above ground level which is the approximate ear height of a typical standing observer.
- *Terrain Elevation*: Elevation contours for the modeling domain were imported into CadnaA which allowed for consideration of terrain shielding where appropriate. The terrain height contours for the modeling domain were generated from elevation information derived from the National Elevation Dataset (NED) developed by the U.S. Geological Survey.
- *Source Sound Levels*: Broadband and octave-band sound power levels (when available) for the potential noise sources for the Project presented in Table 7-1 through Table 7-5 were included in the model.
- *Foliage*: Foliage was included in the heavily vegetated areas to the north, northwest, and southeast of the project buildings. This vegetation will be retained in the proposed plot plan.
- *Ground Attenuation*: Spectral ground absorption was calculated using a G-factor of 0 for the paved areas of the Project site which corresponds to “hard ground”. For all other offsite areas, a G-factor of 0.5 was used which corresponds to “mixed ground”.
- *Directivity*: A directivity correction was applied to the baghouse exhaust stack.

Sound pressure levels due to the operation of all continuous sources operating simultaneously at full load were modeled at the five sound level modeling locations. This is a conservative modeling assumption which will result in higher predicted sound levels relative to various actual part-load and intermittent operation of some of the continuous sources.

Several modeling assumptions inherent in the ISO 9613-2 calculation methodology, or selected as conditional inputs by the user, were implemented in the CadnaA model to ensure conservative results (i.e., higher sound levels), and are described below:

- As per ISO 9613-2, the model assumed favorable conditions for sound propagation, corresponding to a moderate, well-developed ground-based temperature inversion, as might occur on a calm, clear night or equivalently downwind propagation.
- Meteorological conditions assumed in the model (T=10°C and RH=70%) were selected to minimize atmospheric attenuation in the 500 Hz and 1 kHz octave-bands where the human ear is most sensitive.

Figure 7-1 shows the location of the receptors as well as the modeled location of the equipment for both the continuous and the incidental noise model runs.

9.0 SOUND MODELING RESULTS

The resulting sound levels from the Project's sources were exported from the CadnaA model. The results are grouped into continuous and incidental source results. The continuous sources were all modeled cumulatively, and the resulting Project-only sound levels are documented in Table 9-1 below for both unmitigated and mitigated sources during both daytime and nighttime periods.

Table 9-1 Modeled Unmitigated and Mitigated Sound Levels for Continuous Sources

Receptor	Project-Only Continuous Sound Pressure Level (dBA)	
	Unmitigated	Maximum Practical Mitigation
Daytime Tipping Hours (6 am to 7 pm)		
R East1	41	34
R East2	44	32
R South	55	44
R West	46	42
R North	44	34
Nighttime Hours (7 pm to 6 am)		
R East1	41	30
R East2	44	31
R South	46	35
R West	41	36
R North	42	30

The continuous source model results are shown as isopleths over the project area in Figure 9-1 for the daytime results, and in Figure 9-2 for the nighttime results.

The incidental plus daytime continuous source model results are shown in Table 9-2 below. The results from the model are evaluated against ambient sound levels and the MassDEP Noise Policy in Section 10.0 below.

Table 9-2 Modeled Sound Levels for Incidental Plus Continuous Daytime Sources

Receptor	Modeled Project-Only Incidental Sound Pressure Level (dBA)								
	Backup Alarm	Idling Locomotive	Railcar Coupling	Trucking	Street Sweeper	Railcar Pusher	Moving Locomotive w/ Railcars	Open Rail Door	Trucking & Backup Alarm
R East1	34	41	34	34	35	34	34	34	34
R East2	32	41	33	32	32	32	32	32	32
R South	44	44	44	44	45	44	44	44	44
R West	42	42	42	42	42	42	42	42	42
R North	34	41	34	40	35	34	34	34	40

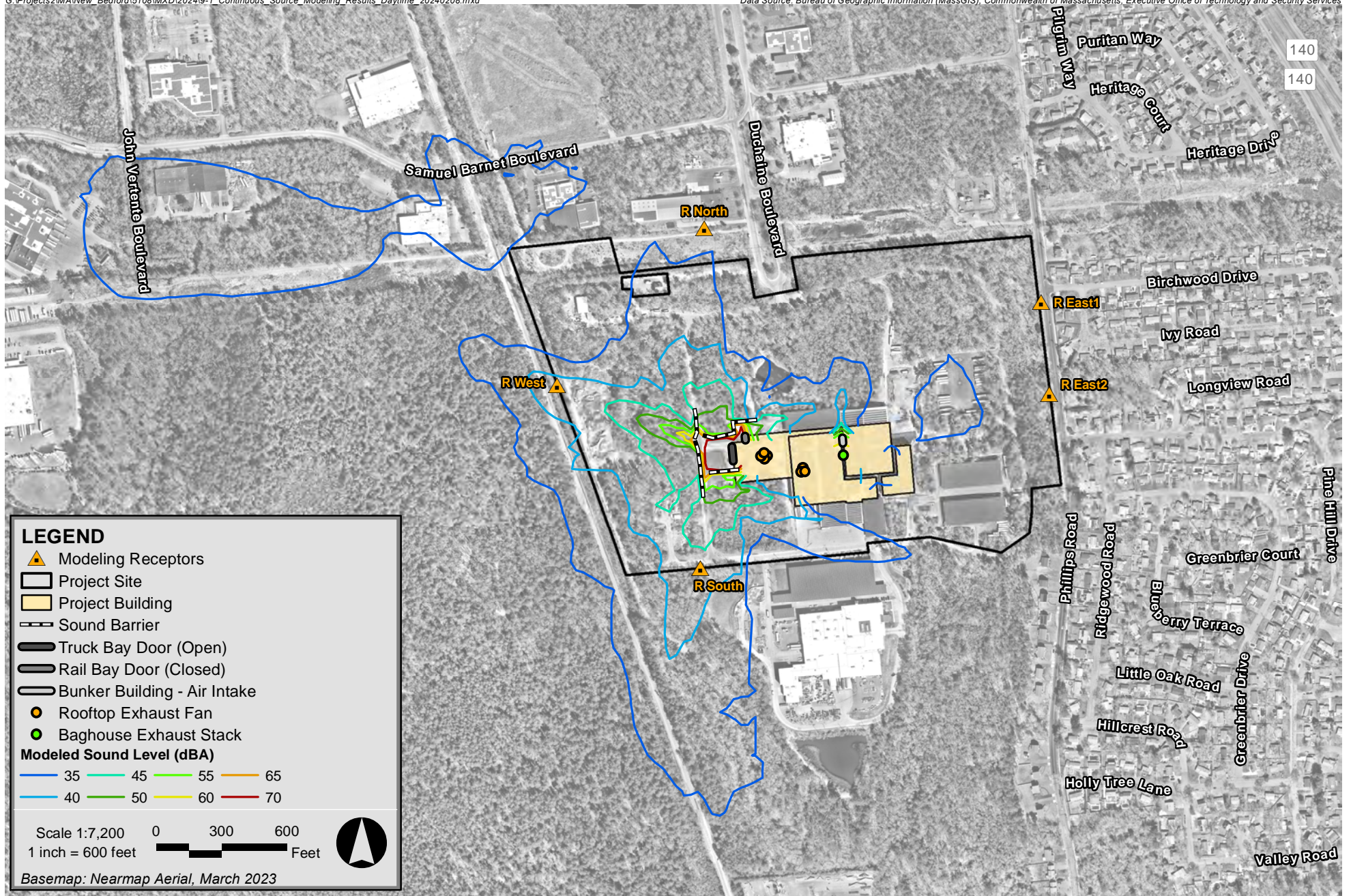

South Coast Renewables New Bedford, Massachusetts



South Coast Renewables New Bedford, Massachusetts

10.0 EVALUATION OF SOUND LEVELS

According to the MassDEP Noise Policy, a source of sound will be considered to be violating the noise regulation at 310 CMR 7.10 if the source increases the broadband sound level by more than 10 dBA above ambient. In addition to limiting the increase in the ambient sound level, the Noise Policy prohibits “pure tone” conditions where the sound pressure level in one octave band frequency is at least 3 dB greater than the sound levels in each of two adjacent frequency bands. The compliance analysis for the noise sources is presented for continuous and incidental sources.

10.1 Continuous Sources

For the continuous sources, the Project Only mitigated sound levels provided in Table 9-1 above are added to the ambient sound levels to calculate the predicted future total sound levels. It is important to note that the sound levels are logarithmic and thus must be added logarithmically. These new future predicted sound levels are then compared to the ambient sound level to document that the increase is at or below 10 dBA. The lowest ambient L₉₀ sound level across the monitoring period is shown for each hour in Table 6-2 of Section 6.7 of this document. For the purposes of this analysis, the lowest individual hour is used to quantify the ambient sound level at the request of MassDEP. Table 10-1 below provides the comparison of the modeled results to the lowest existing ambient sound level for continuous sources during daytime tipping hours (6 am to 7 pm) and during nighttime hours (7 pm to 6 am).

Table 10-1 Modeled Continuous Sound Pressure Levels Compared to Ambient

Receptor	Project Only Sound Level (dBA)	Ambient L ₉₀ Sound Level (dBA)	Total Ambient Plus Project (dBA)	Increase over Ambient (dBA)
Daytime Tipping Hours (6 am to 7 pm)				
R East1	34	39	40	1
R East2	32	39	40	1
R South	44	36	45	8
R West	42	33	43	9
R North	34	37	39	2
Nighttime Hours (7 pm to 6 am)				
R East1	30	34	35	2
R East2	31	32	35	2
R South	35	33	38	4
R West	35	31	37	6
R North	38	33	39	6

Notes:

1. Only whole numbers are shown; calculations were performed using values with additional precision.

10.2 Incidental Sources

For the incidental noise sources, the modeled sound impact of the specific activity is added to the lowest ambient hour during the time window that the activity can occur. As discussed previously, incidental

sources were modeled individually since they are brief in duration and are unlikely to occur simultaneously. For example, the on-site railcar mover would not be used when the locomotive is servicing the site. One exception is trucking and backup alarms which may occur at the same time and were therefore modeled both separately and together. Because the continuous sources will be operating when incidental sources are operating, each incidental source has been modeled with daytime continuous sources operating for this evaluation.

Like the continuous sound levels analysis, it is important to note that the sound levels are logarithmic and thus must be added logarithmically. These new future predicted sound levels are then compared to the ambient sound level to demonstrate that the increase is at or below 10 dBA. The lowest ambient L₉₀ sound level across the monitoring period is shown for each hour in Table 6-1 of Section 6.6 of this document. Table 10-2 below shows the comparison of each activity to ambient conditions along with the time restriction used for the activity.

Table 10-2 Modeled Sound Pressure Levels Compared to Ambient for Continuous Sources Plus Backup Alarms (6 am to 7 pm)

Receptor	Activity Only Sound Level (dBA)	Ambient L ₉₀ Sound Level (dBA)	Total Ambient Plus Project (dBA)	Increase over Ambient (dBA)
R East1	34	39	40	1
R East2	32	39	40	1
R South	44	36	45	8
R West	42	33	43	9
R North	34	37	39	2

Notes:

1. Only whole numbers are shown; calculations were performed using values with additional precision.

Table 10-3 Modeled Sound Pressure Levels Compared to Ambient for Continuous Sources Plus Idling Locomotive (7 am to 7 pm)

Receptor	Activity Only Sound Level (dBA)	Ambient L ₉₀ Sound Level (dBA)	Total Ambient Plus Project (dBA)	Increase over Ambient (dBA)
R East1	41	43	45	2
R East2	41	42	45	3
R South	44	37	45	7
R West	43	33	43	10
R North	41	37	42	5

Notes:

1. Only whole numbers are shown; calculations were performed using values with additional precision.

Table 10-4 Modeled Sound Pressure Levels Compared to Ambient for Continuous Sources Plus Railcar Coupling (6 am to 7 pm)

Receptor	Activity Only Sound Level (dBA)	Ambient L ₉₀ Sound Level (dBA)	Total Ambient Plus Project (dBA)	Increase over Ambient (dBA)
R East1	34	39	41	1
R East2	33	39	40	1
R South	44	36	45	8
R West	42	33	43	9
R North	34	37	39	2

Notes:

1. Only whole numbers are shown; calculations were performed using values with additional precision.

Table 10-5 Modeled Sound Pressure Levels Compared to Ambient for Continuous Sources Plus Truck Inbound and Outbound Operations (6 am to 7 pm)²

Receptor	Activity Only Sound Level (dBA)	Ambient L ₉₀ Sound Level (dBA)	Total Ambient Plus Project (dBA)	Increase over Ambient (dBA)
R East1	34	39	40	1
R East2	32	39	40	1
R South	44	36	45	8
R West	42	33	43	10
R North	40	37	42	5

Notes:

1. Only whole numbers are shown; calculations were performed using values with additional precision.
2. Note that trucks may arrive onsite as early as 5 am, but the tipping doors will be closed, so the continuous sound level and therefore the cumulative sound level will be much lower between 5 am and 6 am.

Table 10-6 Modeled Sound Pressure Levels Compared to Ambient for Continuous Sources Plus Street Sweeper Operations (10 am to 4 pm)

Receptor	Activity Only Sound Level (dBA)	Ambient L ₉₀ Sound Level (dBA)	Total Ambient Plus Project (dBA)	Increase over Ambient (dBA)
R East1	35	45	45	0
R East2	32	42	42	0
R South	45	37	45	8
R West	43	33	43	10
R North	35	37	39	2

Notes:

1. Only whole numbers are shown; calculations were performed using values with additional precision.

Table 10-7 Modeled Sound Pressure Levels Compared to Ambient for Continuous Sources Plus Railcar Pusher (6 am to 7 pm)

Receptor	Activity Only Sound Level (dBA)	Ambient L ₉₀ Sound Level (dBA)	Total Ambient Plus Project (dBA)	Increase over Ambient (dBA)
R East1	34	39	40	1
R East2	32	39	40	1
R South	44	36	45	8
R West	42	33	43	9
R North	34	37	39	2

Notes:

1. Only whole numbers are shown; calculations were performed using values with additional precision.

Table 10-8 Modeled Sound Pressure Levels Compared to Ambient for Continuous Sources Plus Moving Locomotive with Railcars (6 am to 7 pm)

Receptor	Activity Only Sound Level (dBA)	Ambient L ₉₀ Sound Level (dBA)	Total Ambient Plus Project (dBA)	Increase over Ambient (dBA)
R East1	34	39	41	1
R East2	32	39	40	1
R South	44	36	45	8
R West	42	33	43	9
R North	34	37	39	2

Notes:

1. Only whole numbers are shown; calculations were performed using values with additional precision.

Table 10-9 Modeled Sound Pressure Levels Compared to Ambient for Continuous Sources Plus Open Railcar Bay Door (6 am to 7 pm)

Receptor	Activity Only Sound Level (dBA)	Ambient L ₉₀ Sound Level (dBA)	Total Ambient Plus Project (dBA)	Increase over Ambient (dBA)
R East1	34	39	40	1
R East2	32	39	40	1
R South	44	36	45	8
R West	42	33	43	9
R North	35	37	39	2

Notes:

1. Only whole numbers are shown; calculations were performed using values with additional precision.

Table 10-10 Modeled Sound Levels Compared to Ambient for Continuous Sources Plus Backup Alarm and Truck Inbound and Outbound Operations (6 am to 7 pm)

Receptor	Activity Only Sound Level (dBA)	Ambient L ₉₀ Sound Level (dBA)	Total Ambient Plus Project (dBA)	Increase over Ambient (dBA)
R East1	34	39	40	1
R East2	32	39	40	1
R South	44	36	45	8
R West	42	33	43	10
R North	40	37	42	5

Notes:

1. Only whole numbers are shown; calculations were performed using values with additional precision.

10.3 Pure Tone Analysis

MassDEP’s Noise Policy prohibits “pure tone” conditions where the sound pressure level in one octave band is 3 dB or more than the sound levels in each of the two adjacent octave bands. The logarithmic sum of the ambient sound levels and the predicted future sound levels are shown in Appendix B. The analysis demonstrates that operations from the Facility will not create any “pure tones.”

11.0 BEST AVAILABLE CONTROL TECHNOLOGY

This section documents that the Project meets the "top case" sound suppression/mitigation measures by delivering the lowest sound level increase above background unless these measures are eliminated based upon technological or economic infeasibility. If the "top case" measures are eliminated, the most effective measures that are feasible are implemented. This process is similar to the traditional "top-down" Best Available Control Technology (BACT) process.

11.1 BACT Guidance

MassDEP defines BACT at 310 CMR 7, which states in part:

BEST AVAILABLE CONTROL TECHNOLOGY means an emission limitation based on the maximum degree of reduction of any regulated air contaminant emitted from or which results from any regulated facility which the Department, on a case-by-case basis taking into account energy, environmental, and economic impacts and other costs, determines is achievable for such facility through application of production processes and available methods, systems and techniques for control of each such contaminant. The best available control technology determination ... may include a design feature, equipment specification, work practice, operating standard, or combination thereof.

The MassDEP form BAQ Sound provides the following guidance on BACT as it applies to noise:

When proposing sound suppression/mitigation measures, similar to the traditional "top-down" BACT process, the "top case" sound suppression/mitigation measures which deliver the lowest sound level increase above background are required to be implemented, unless these measures can be eliminated based upon technological or economic infeasibility. An applicant cannot "model out" of the use of the "top case" sound suppression/ mitigation measures by simply demonstrating that predicted sound levels at the property line when employing a less stringent sound suppression/mitigation strategy will result in a sound level increase of less than or equal to the 10 dBA (decibel, A-Weighted) above background sound level increase criteria contained in the MassDEP Noise Policy. A 10 dBA increase is the maximum increase allowed by MassDEP; it is not the sound level increase upon which the design of sound suppression/mitigation strategies and techniques should be based. Also, take into consideration that the city or town that the project is located in may have a noise ordinance (or similar) that may be more stringent than the criteria in the MassDEP Noise Policy.

The traditional “top-down” BACT process is further described in the MassDEP Guidance *Best Available Control Technology (BACT) Guidance Air Pollution Control Requirements for Construction, Substantial Reconstruction or Alteration of Facilities that Emit Air Contaminants*⁶. That document states in part:

In brief, the Top-Down process is a ranking of all available control technologies in descending order of control effectiveness. You must first examine the most stringent ("Top-Case") alternative. MassDEP will presume this represents BACT unless you can demonstrate – and we agree – that it is not feasible for technical, energy, environmental or economic reasons. If you eliminate the most stringent control alternative in this fashion, then you must consider the second best, and so on.

This analysis follows the guidance summarized above.

11.2 BACT Approach

SCR understands it cannot "model out" of the use of the "top case" sound suppression/mitigation measures. This analysis does not propose to employ any less stringent sound suppression/mitigation strategy, even if such a strategy would result in a sound level increase of less than or equal to the 10 dBA above background sound level increase criteria contained in the MassDEP Noise Policy. SCR understands that a 10 dBA increase is the maximum increase allowed by MassDEP; and has not based on the design of sound suppression/mitigation strategies and techniques on this sound level increase. Also, SCR has taken into consideration that the City of New Bedford may have a noise ordinance (or similar) that may be more stringent than the criteria in the MassDEP Noise Policy; per Section 5.3 of this analysis, the City of New Bedford has no quantitative noise regulations applicable to the Project.

Instead, SCR has conducted a Top-Down BACT analysis following MassDEP guidance. Broadly, sound suppression/mitigation measures fall into two categories:

- Source-by-Source BACT Measures, which can include the elimination of specific sound-generating activities, or their suppression/mitigation at the source; and
- Facility-Wide BACT Measures, which can include site configuration to minimize sound impacts, and broader mitigation measures (such as barriers) that can suppress/mitigate sound from multiple individual sources.

Each category is addressed in turn below, followed by the conclusions of the BACT analysis.

⁶ June 2011, <https://www.mass.gov/doc/best-available-control-technology-bact-guidance/download>

11.3 Source-by-Source BACT Measures

The source-by-source proposed attenuation is described in Section 7 of this assessment. This section specifically addresses additional measures that were considered but deemed infeasible for technical, energy, environmental or economic reasons.

11.3.1 Continuous Noise Sources

1. Rooftop Exhaust Fans –

Controls that were considered but deemed infeasible: Because of diminishing returns associated with layered, incremental sound mitigation measures, reductions beyond 16 dBA per fan are unlikely using low-sound fans, barriers, or silencers. Further reductions are not feasible without reducing the ability of the fans to perform the required air exchanges. Larger or more numerous fans would be required. The overall sound produced by the larger or more numerous fans would not have sound pressure levels significantly lower than the proposed configuration, because there would be larger/more numerous sound generating sources. To a large extent, the amount of sound generated is a function of the amount of air that must be moved, and that amount of air cannot be reduced without impacting worker safety, worker comfort, and proper facility operation. Additionally, space constraints may prevent the use of larger or more numerous fans, and having larger openings or more openings may create a situation where in-building noise can escape in amounts that could contribute to overall Project sound impacts. As discussed below, further reductions would need to be made to each continuous source to have a noticeable effect at residences.

Diagnostic modeling was performed to confirm that the use of more numerous, quieter fans would not significantly decrease Project sound impacts at the residential receptors.

Proposed Top-Down BACT: Sound level reductions as described in Section 7 which could be achieved by using quieter fans, rooftop barriers, or fan silencers.

2. Loading Bay Doors

Controls that were considered but deemed infeasible: Closing doors is a feasible and effective mitigation strategy that SCR will use whenever possible. The sound level assessment is conducted assuming the trucking doors are open because SCR cannot commit to keeping the doors closed in all conditions. Movement of material and equipment into and out of the buildings will require use of the doors. As such, this analysis takes the most conservative approach.

The continuous source model includes the assumption that the roll-up trucking doors on the MSW building are always open during tipping hours. Use of high-speed roll-up doors on the MSW building could be implemented, if required, to minimize the amount of time that the roll-up doors need to be open.

Proposed Top-Down BACT: The trucking roll-up doors will use high-performance STC-30 roll-up doors that will remain closed outside of waste delivery hours (7 pm to 6 am).

3. Railcar Loading Bay/Doors

Controls that were considered but deemed infeasible: The logistics of closing doors during railcar loading imposes safety and significant operational constraints. The limited amount of time that the railcar loading bay doors are open means that the noise impact from this source is not contributing to overall long-term impacts, and the operational and logistical difficulties with door use renders the option infeasible.

Proposed Top-Down BACT: The trucking roll-up doors will use high-performance STC-30 roll-up doors that will remain closed unless there is an active rail delivery taking place, which will be infrequent and of short duration.

4. Baghouse intake

Controls that were considered but deemed infeasible: While a larger, more extensive acoustic louver could be used (with a larger associated building opening to allow sufficient airflow), its use would not be a feasible noise mitigation measure because reducing baghouse intake noise would not significantly reduce overall Project sound levels.

Proposed Top-Down BACT: Use of an acoustic intake louver to mitigate sound as described in Section 7.

5. Baghouse exhaust:

Controls that were considered but deemed infeasible: While a silencer could be used (possibly with a larger blower to overcome the increased pressure drop), its use would not be a feasible noise mitigation measure because reducing baghouse exhaust noise would not significantly reduce overall Project sound levels. Diagnostic modeling was used to confirm that a silencer would not significantly decrease overall Project sound levels.

Proposed Top-Down BACT: Standard duct losses should reduce the baghouse exhaust sound levels as described in Section 7.

11.3.2 Intermittent Noise Sources

1. Backup Alarm:

Controls that were considered but deemed infeasible: Site and operational constraints prevent the arrangement of the MSW unloading to avoid having trucks reverse direction (and avoid using backup beepers). This is commonplace in almost all solid waste handling facilities in the Commonwealth. SCR will not own the inbound waste delivery trucks, and cannot mandate installation of “white noise” or similar technologies to reduce beeper noise. While there are limited situations where it is legal to disable the backup beeper on a truck, the beepers are serving an important onsite safety function (to avoid accidents), and trucks are typically not equipped with the ability to defeat the beeper alarm.

Proposed Top-Down BACT: SCR will commit to white noise or squawking back-up alarms for their on-site heavy equipment including the railcar mover. The MSW truck unloading has been sited to the west side

of the project to minimize sound related impacts on residences to the east. The site is oriented so that buildings form a noise barrier between the location of the reversing MSW truck and the residences located east, northeast and southeast of the subject site. The glass unloading was designed as a “drive forward” delivery system, eliminating backup alarms as a noise source at that location. Time of day operational restrictions mitigate noise impacts.

2. Idling Locomotive

Controls that were considered but deemed infeasible: Locomotive engine noise is regulated federally by 40 CFR 201. SCR will not own the locomotives, and by the nature of interstate rail operations different locomotives may deliver and pick up from the SCR facility. It is therefore not feasible to install additional noise controls on the locomotives, beyond what is required by federal regulation.

Proposed Top-Down BACT: Daytime scheduling of locomotive drop-off and pickups, and use of the electric railcar pusher to minimize locomotive activity onsite. SCR’s proposed electric railcar mover has the ability to stage and couple railcars together to reduce on-site locomotive time, and to stage and couple railcars together to increase the distance between the locomotive and the residential receptors. Modeling conservatively assumes that the locomotive will be idling for a period of 15 minutes and moving railcars for a period of 30 minutes. This is a conservative assumption. If the locomotive needs to be onsite for more than 45 minutes, on-site tipping operations will cease until the locomotive leaves the facility.

3. Railcar Coupling

Controls that were considered but deemed infeasible: Further reductions in coupling speed are infeasible because there is a minimum speed that will allow the railcar coupler system to function. If coupling occurs too slowly the knuckle elements will not push past each other to create required the connection. SCR will use existing railcar rolling stock, will likely not own the railcars used, and will have no opportunity to engineer or implement any alternative railcar connection system.

Proposed Top-Down BACT: Reduced-speed coupling, facilitated by the use of an electric railcar pusher instead of a diesel pusher.

4. Truck Inbound and Outbound Operations

Controls that were considered but deemed infeasible: Further speed restrictions were determined to be infeasible because they would prevent the efficient movement of material into and out of the site and would increase the chances of unnecessary queuing and idling. At this point in time, SCR will not own or operate the trucks and cannot mandate sound mitigation retrofits beyond compliance with federal and state transportation requirements.

Proposed Top-Down BACT: Use of an existing industrially zoned site, routing of truck traffic away from residential areas, use of rail transport to reduce total truck trips. Use of a speed limit and location of weigh scales on the west side of the property has already been instituted to minimize sound from trucking operations. Time-of-day operational restrictions

11.3.3 Other Facility Noise.

Other facility noise will include indoor material handling, HVAC for conditioned spaces, worker commutes, and general employee activity onsite.

Proposed mitigations: Use of an existing industrially-zoned site, routing of traffic away from residential areas (e.g Phillips Road use exclusion), use a speed limit, use of buildings to mitigate material handling noise, specification of low-noise ancillary equipment where needed to ensure that sound will not contribute to total facility sound. SCR expects no tailgate “slamming” activity (as deliveries will use roll-off, packer, and live-floor trailers).

Sound Level with source reduction: Insignificant, that is, remaining sound from other facility noise is ten decibels or more quieter than other onsite sources. Because the decibel scale is logarithmic, a sound source that is more than 10 decibels quieter than other sources will not contribute to overall total project sound levels.

Other controls that were considered but deemed infeasible: No additional controls are feasible, as the sources already have no contribution to offsite sound levels.

11.4 Facility-Wide BACT Measures

The Project design incorporates the use of an industrially-zoned parcel, indoor material handling operations, a layout to direct sound away from sensitive receptors, and time-of-day operational restrictions as top-case BACT measures. Remaining facility-wide noise control measures could include the use of sound barriers.

The potential use of sound barriers was reviewed in detail. Noise barriers are most effective when placed close to the source of sound, or close to the receptor. A system of noise barriers to the north, west, and south of the solid waste tipping area has been proposed. The barriers have gaps to allow the railroad and trucking roads to pass through. The barriers are shown in Figure 7-1, 9-1, and 9-2.

12.0 CONCLUSIONS

A comprehensive sound level modeling assessment was conducted for the SCR Project and has followed the scope and methodology as approved by MassDEP. In addition, ambient sound levels were measured to characterize the existing background sound levels within the area. Results of the comprehensive sound level assessment demonstrate that sound levels from the Project with the sound mitigation measures described in this report or equivalent design changes will meet the requirements set forth in the MassDEP Noise Policy at all property line and residential locations, and that the Project will not cause a condition of noise pollution.

Sound pressure levels due to the operation of all stationary equipment operating simultaneously at full load were predicted at the five sound level modeling locations. Simultaneous operation at full load is a conservative modeling assumption, which will result in higher predicted sound levels relative to various actual partial-load and intermittent operation of some of the stationary sources. All the future predicted total sound levels documented in Table 10-1 above show compliance with the MassDEP Noise Policy which restricts the increase over ambient sound levels to 10 dBA or less during both daytime and nighttime periods. In addition, operations from the Facility will not create any “pure tones”. Throughout the analysis, SCR has documented that sound impacts will be avoided, minimized, and mitigated to the extent feasible.

A similar analysis was performed for the Project incidental noise sources. SCR has mitigated Project generated sound from all the incidental noise sources to the maximum extent practicable. In addition, although these sources are regulated by other agencies, they will also meet the ambient-based sound level limit set forth in the MassDEP Noise Policy as documented in Table 10-2 through Table 10-10. Therefore, this assessment shows that the impacts from all sounds due to the Project will be mitigated to the extent feasible and will not cause a condition of noise pollution. Additionally, pursuant to 310 CMR, 16.40(4)(g) the facility will not cause a nuisance sound condition which would constitute a danger to the public health, safety, or the environment.

Appendix A

Data Source Documentation



COOK

UCIC

Exhaust Fan Info

365UCIC

Tubular Centrifugal Blower

Upblast

Roof Mounted

Class I

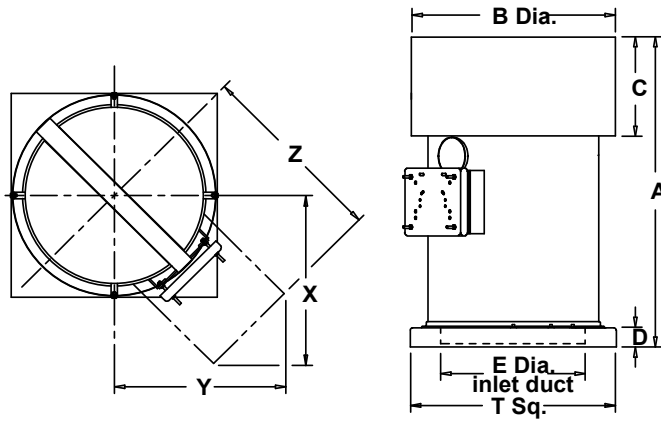

Dimensions are in inches.

T Sq.	62
A	99-1/8
B Dia.	61-15/16
C	35
D	3
E	41-1/2
X Max	53-3/4
Y Max	53-3/4
Z Max	52-1/2
Max Mtr Frame	326T
Roof Open	57-1/2

UCIC

Performance (Belt Drive)

Catalog Number	CFM	SP	Fan RPM	Power* HP	Motor HP	OVEL (mph)	TSPD (mph)	SE	TEMP (°F)	ELEV (Ft)	*Drive Loss Included
365UCIC	25000	1	923	12.5	15	16.8	100	33%	70	0	5%

Sound Data 8 Octave Bands 10⁻¹² Watts

1	2	3	4	5	6	7	8	LwA	dBA
97	99	94	90	90	84	75	68	94	82

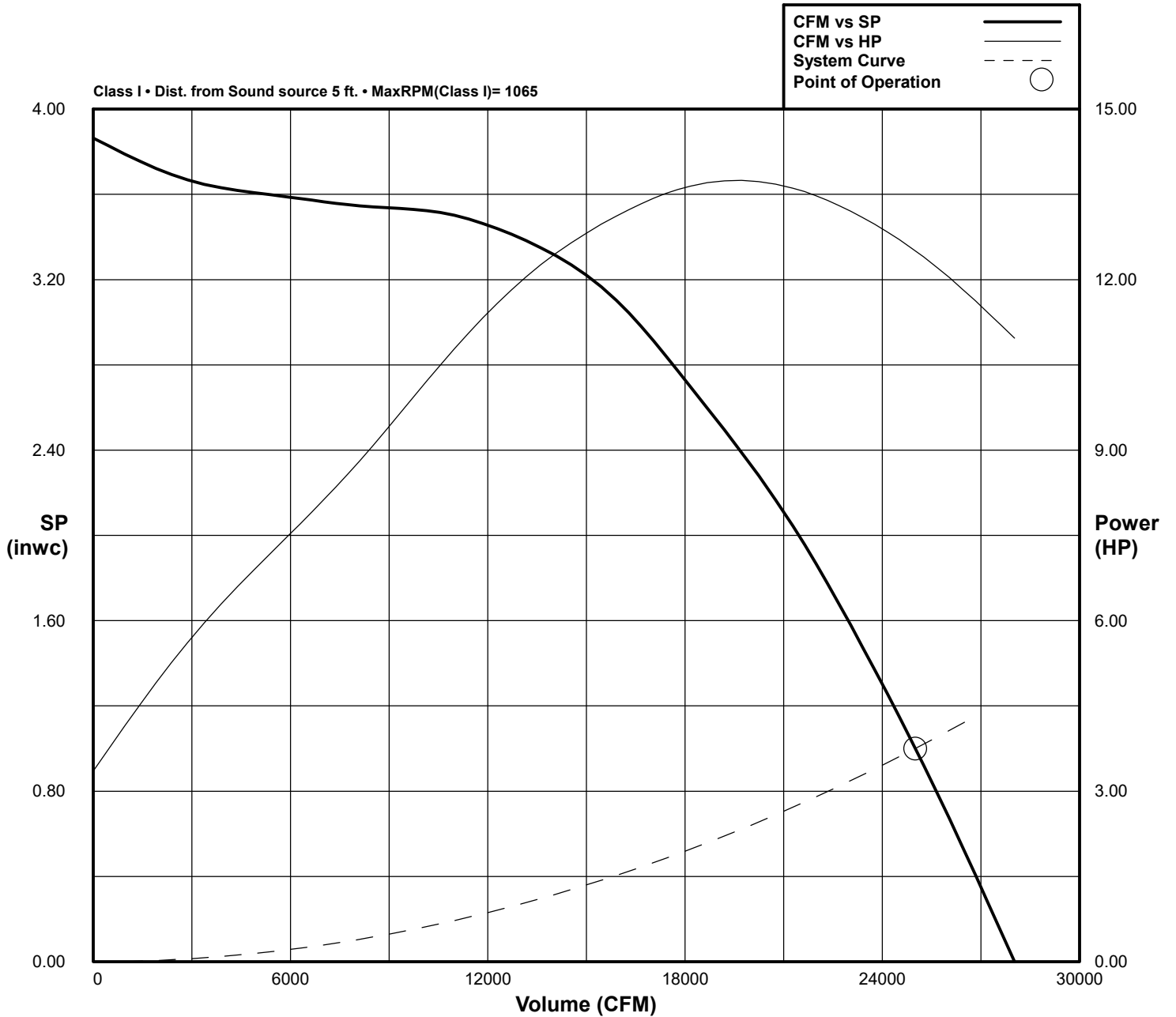



The New York Blower Company
Fan-to-Size
Fan Selection Detail

Fan Design

Product: HPBC
 Type: Backward-Inclined
 Size: 40
 Fan Class: N/A
 Wheel Type: Backward Inclined (backward curved: BC) - BC
 Wheel Material: Carbon Steel w/min yield str. of 80Ksi
 Wheel Weight: 335.0 lb
 Wheel WR²: 439 lb-ft²
 Percent Width: 100%
 Percent Diameter: 100.0%
 Outlet Area: 4.548 sq. ft.
 Options: None
 Axial thrust load is 801.4 lbf.

Calculation Mode: Find Speed

Drive Type: Belt
 Arrangement: 1
 Outlet Velocity: 3628 ft/min
 Static Efficiency: 81.52%
 Total Efficiency: 85.5%
 Operating Temp: 70° F
 Maximum Temp: 100° F
 Maximum Speed: (1) 2244 RPM
 Velocity Pressure: 0.822 in wg
 Fan Static Pressure: 17 in wg
 Fan Total Pressure: 17.8 in wg
 Altitude: 0 ft

Conditions (Actual Volume; Fan Static Pressure)

	Flow	Pressure	Power	Speed	Speed Limit (2)	Density	Altitude	Inlet Temp.
	<u>ACFM</u>	<u>in wg (FSP)</u>	<u>bhp</u>	<u>rpm</u>	<u>rpm</u>	<u>lb/ft³</u>	<u>ft</u>	<u>f</u>
Operating	16500	17	54.2	1584	2260	0.0750	0	70
Cold	16500	17	54.2	1584	2260	0.0750	0	70
Standard	16500	17	54.2	1584	2260	0.0750	0	70

(1) Speed Limit at Maximum Temperature (2) Speed Limit at indicated Inlet Temperature

My Sales Representative

MassFlow Air Products
 419 Main Street Sturbridge, MA 01566-1159, USA
 (P) 508-765-0266, (F) 508-765-0328
 sales@massflowair.com



The New York Blower Company
Fan-to-Size
Fan Selection Detail

Sound Power Level Ratings

Sound power and sound pressure levels are shown in decibels. (Power levels reference 10-12 watts and pressure levels reference 2x10⁻⁷ microbar.) Sound power ratings are calculated per AMCA Standard 301. Ratings do not include the effects of duct end correction. Sound levels do not include motors or drives. Pressure levels are estimated. A-weighting is per ANSI S.1.42-2001 (R2011).

Fan Sound

Center Freq (Hz)	63	125	250	500	1000	2000	4000	8000	Overall
Octave	1	2	3	4	5	6	7	8	
Inlet Total Power, dB	104	98	93	94	92	90	84	79	106
A-Weighting	-26.2	-16.1	-8.6	-3.2	0	1.2	1	-1.1	
Convert To Pressure	-4.0	-4.0	-4.0	-4.0	-4.0	-4.0	-4.0	-4.0	
Inlet Total Pressure, dBA	74	78	81	87	88	87	81	74	93
Outlet Total Power, dB	104	98	93	94	92	90	84	79	106
A-Weighting	-26.2	-16.1	-8.6	-3.2	0	1.2	1	-1.1	
Convert To Pressure	-4.0	-4.0	-4.0	-4.0	-4.0	-4.0	-4.0	-4.0	
Outlet Total Pressure, dBA	74	78	81	87	88	87	81	74	93
Fan Total Power, dB	107	101	96	97	95	93	87	82	109
Housing Radiated Noise	-7	-11	-16	-18	-15	-15	-16	-17	
A-Weighting	-26.2	-16.1	-8.6	-3.2	0	1.2	1	-1.1	
Convert To Pressure	-4.0	-4.0	-4.0	-4.0	-4.0	-4.0	-4.0	-4.0	
Fan Total Pressure, dBA	70	70	68	72	76	75	68	60	81

Directivity/Reflection is a quarter-spherical radiation (Q = 4); Distance is 3 ft.

At 3 ft, the estimated sound pressure level:

1. outside the fan due to an open inlet OR outlet is 93 dBA.
2. housing radiated noise when inlet and outlet are ducted away from listening point is 81 dBA.

The sound power and pressure levels displayed here are estimated values based on tests and ratings conducted in accordance with AMCA standards 300 and 301. AMCA does not certify any of these ratings. See the Policy on Sound for more details.



The New York Blower Company

Fan-to-Size

Fan Selection Detail

Product: HPBC
Material: Carbon Steel w/min yield str. of 80Ksi
Fan Size: 40
Arrangement: 1
Wheel Type: Backward Inclined (backward curved: BC) - BC
Options: None

Actual Volume Flow Rate: 16500 ACFM
Fan Static Pressure: 17 in wg
Speed: 1584 rpm
Power: 54.2 bhp

Inlet Temperature: 70 °f
Altitude: 0 ft
Density: 0.0750 lb/ft3
Outlet Velocity: 3628 ft/min

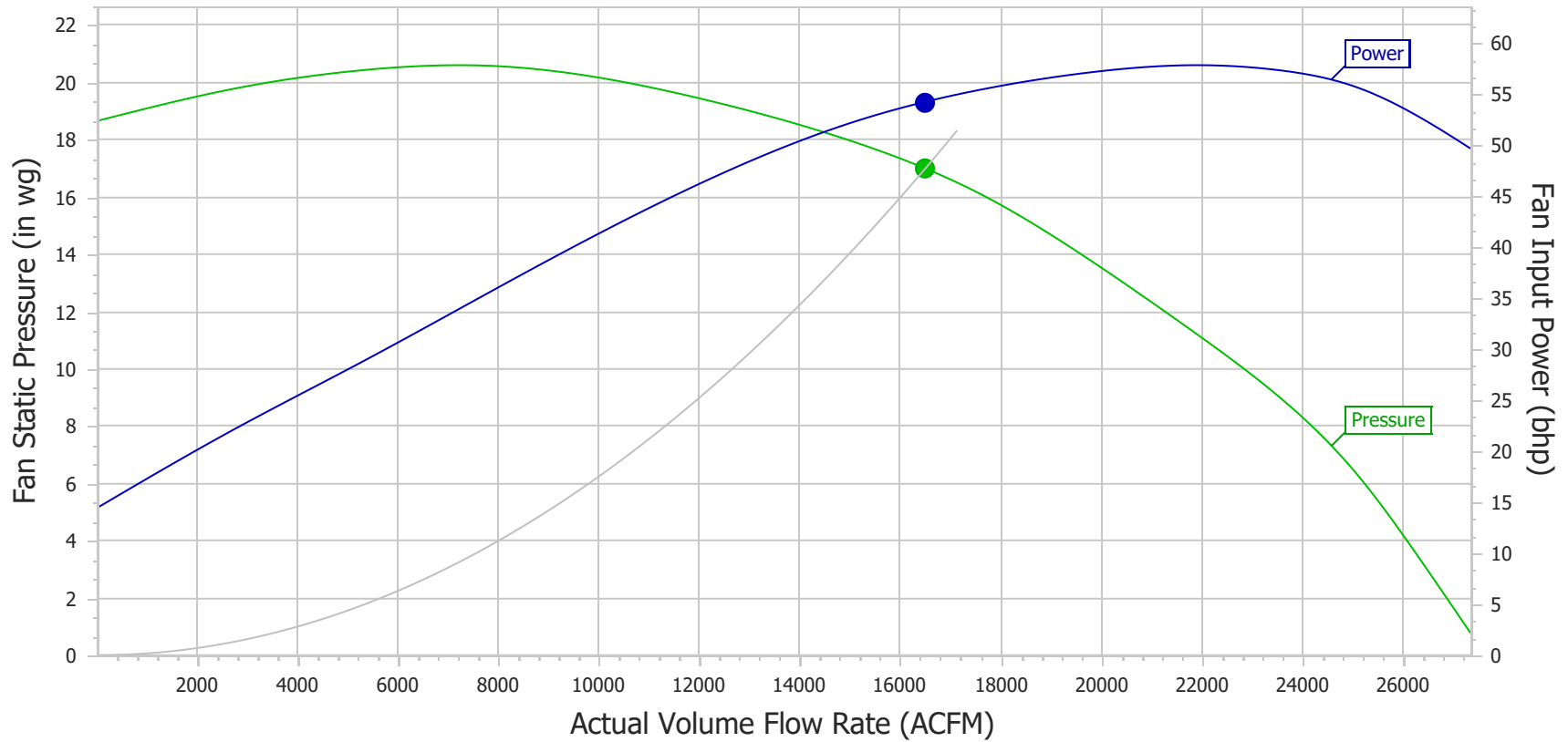



The New York Blower Company
Fan-to-Size
Fan Selection Detail

Fan Design

Product: HPBC
 Type: Backward-Inclined
 Size: 33
 Fan Class: N/A
 Wheel Type: Backward Inclined (backward curved: BC) - BC
 Wheel Material: Carbon Steel w/min yield str. of 80Ksi
 Wheel Weight: 160.0 lb
 Wheel WR²: 141 lb-ft²
 Percent Width: 100%
 Percent Diameter: 100.0%
 Outlet Area: 3.037 sq. ft.
 Options: None
 Axial thrust load is 433.8 lbf.

Calculation Mode: Find Speed

Drive Type: Belt
 Arrangement: 1
 Outlet Velocity: 3490 ft/min
 Static Efficiency: 79.41%
 Total Efficiency: 83.7%
 Operating Temp: 70° F
 Maximum Temp: 100° F
 Maximum Speed: (1) 2761 RPM
 Velocity Pressure: 0.76 in wg
 Fan Static Pressure: 14 in wg
 Fan Total Pressure: 14.8 in wg
 Altitude: 0 ft

Conditions (Actual Volume; Fan Static Pressure)

	Flow	Pressure	Power	Speed	Speed Limit (2)	Density	Altitude	Inlet Temp.
	<u>ACFM</u>	<u>in wg (FSP)</u>	<u>bhp</u>	<u>rpm</u>	<u>rpm</u>	<u>lb/ft³</u>	<u>ft</u>	<u>f</u>
Operating	10600	14	29.5	1778	2780	0.0750	0	70
Cold	10600	14	29.5	1778	2780	0.0750	0	70
Standard	10600	14	29.5	1778	2780	0.0750	0	70

(1) Speed Limit at Maximum Temperature (2) Speed Limit at indicated Inlet Temperature

My Sales Representative

MassFlow Air Products
 419 Main Street Sturbridge, MA 01566-1159, USA
 (P) 508-765-0266, (F) 508-765-0328
 sales@massflowair.com



The New York Blower Company
Fan-to-Size
Fan Selection Detail

Sound Power Level Ratings

Sound power and sound pressure levels are shown in decibels. (Power levels reference 10-12 watts and pressure levels reference 2x10⁻⁷ microbar.) Sound power ratings are calculated per AMCA Standard 301. Ratings do not include the effects of duct end correction. Sound levels do not include motors or drives. Pressure levels are estimated. A-weighting is per ANSI S.1.42-2001 (R2011).

Fan Sound

Center Freq (Hz)	63	125	250	500	1000	2000	4000	8000	Overall
Octave	1	2	3	4	5	6	7	8	
Inlet Total Power, dB	92	95	87	90	88	88	89	85	99
A-Weighting	-26.2	-16.1	-8.6	-3.2	0	1.2	1	-1.1	
Convert To Pressure	-4.0	-4.0	-4.0	-4.0	-4.0	-4.0	-4.0	-4.0	
Inlet Total Pressure, dBA	62	75	75	83	84	85	86	80	91
Outlet Total Power, dB	92	95	87	90	88	88	89	85	99
A-Weighting	-26.2	-16.1	-8.6	-3.2	0	1.2	1	-1.1	
Convert To Pressure	-4.0	-4.0	-4.0	-4.0	-4.0	-4.0	-4.0	-4.0	
Outlet Total Pressure, dBA	62	75	75	83	84	85	86	80	91
Fan Total Power, dB	95	98	90	93	91	91	92	88	102
Housing Radiated Noise	-7	-10	-15	-16	-15	-14	-15	-16	
A-Weighting	-26.2	-16.1	-8.6	-3.2	0	1.2	1	-1.1	
Convert To Pressure	-4.0	-4.0	-4.0	-4.0	-4.0	-4.0	-4.0	-4.0	
Fan Total Pressure, dBA	58	68	63	70	72	74	74	67	80

Directivity/Reflection is a quarter-spherical radiation (Q = 4); Distance is 3 ft.

At 3 ft, the estimated sound pressure level:

1. outside the fan due to an open inlet OR outlet is 91 dBA.
2. housing radiated noise when inlet and outlet are ducted away from listening point is 80 dBA.

The sound power and pressure levels displayed here are estimated values based on tests and ratings conducted in accordance with AMCA standards 300 and 301. AMCA does not certify any of these ratings. See the Policy on Sound for more details.



The New York Blower Company

Fan-to-Size

Fan Selection Detail

Product: HPBC
Material: Carbon Steel w/min yield str. of 80Ksi
Fan Size: 33
Arrangement: 1
Wheel Type: Backward Inclined (backward curved: BC) - BC
Options: None

Actual Volume Flow Rate: 10600 ACFM
Fan Static Pressure: 14 in wg
Speed: 1778 rpm
Power: 29.5 bhp

Inlet Temperature: 70 °f
Altitude: 0 ft
Density: 0.0750 lb/ft3
Outlet Velocity: 3490 ft/min

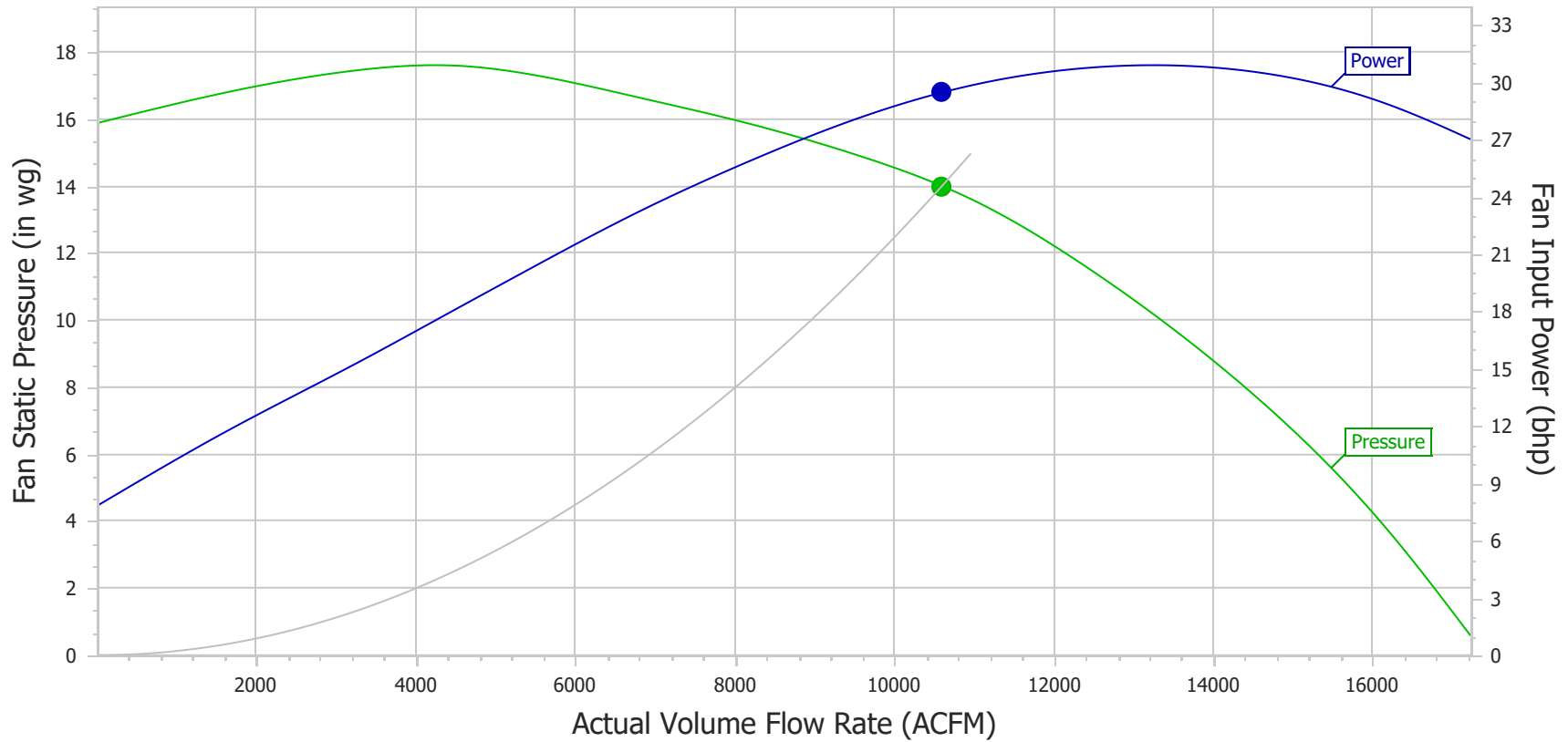

THE RIGHT SOLUTION
FOR MODERN RAIL LOGISTIC



WHY ZEPHIR

PORTS



CARGO



WE KNOW THE WAY TO MAKE IT POSSIBLE

EXPERTISE

Over 45 years of experience in the market

VERSATILITY

Custom made solutions for the special needs applications

RELIABILITY

Built to last with longlife design

INNOVATION

The latest technology available on board

SAFETY

Conforms with the highest safety regulations

WIDE RANGE OF PRODUCTS

40 models offered

APPLICATION AREAS

MINES



INDUSTRIAL APPLICATIONS



WORKSHOPS



RAILWAYS



TRANSPORT PASSENGERS



ELECTRIC RANGE APPLICATIONS

RAIL PASSENGER - USA



METRO - BRAZIL



METRO - KOREA



LOGISTIC - AUSTRALIA



LIGHTRAIL - CANADA



RAIL PASSENGER - POLAND



WORKSHOP - ITALY



CHEMICAL INDUSTRY - SWEDEN



LOGISTIC - SWEDEN



SPECIAL AND CUSTOM MACHINES

KUBO with snowplow



KUBO with diesel engine



KUBO with cabin



* dry straight level track | ** starting peak performance

* dry straight level track | ** starting peak performance

Line CRAB	Model	Draw Bar Pull *	Max Towing Capacity **	Weight	Dimensions LxWxH	Rail road
	1500 E	15 kN	300 t	4 t	2180 mm 1830 mm 1550 mm	
	1800 E	20 kN	400 t	4 t	2180 mm 1830 mm 1550 mm	
	2100 E	26 kN	520 t	5,2 t	2880 mm 2050 mm 2435 mm	
	3100 E	36 kN	730 t	6,6 t	3100 mm 2450 mm 2435 mm	
	5000 E	50 kN	1000 t	9 t	3850 mm 2200 mm 2650 mm	

Line CRAB EVO	Model	Draw Bar Pull *	Max Towing Capacity **	Weight	Dimensions LxWxH	Rail road
	3200 EVO	36 kN	730 t	6,6 t	2504 mm 2200 mm 2500 mm	
	4200 EVO	36 kN	730 t	7,5 t	2504 mm 2200 mm 2500 mm	

Line LOK E	Model	Draw Bar Pull *	Max Towing Capacity **	Weight	Dimensions LxWxH	Rail road
	7.90 E	70 kN	1400 t	16 t	4800 mm 2500 mm 3400 mm	
	10.90 E	100 kN	2000 t	20 t	4800 mm 2500 mm 3400 mm	
	13.90 E	130 kN	2600 t	24 t	4800 mm 2500 mm 3400 mm	
	MPV E	30 kN	600 t	14 t	4800 mm 2500 mm 3375 mm	

Line KUBO	Model	Draw Bar Pull *	Max Towing Capacity **	Weight	Dimensions LxWxH	Rail only
	1.200 E	18 kN	360 t	5t	2600 mm 2200 mm 1300 mm	
	2.500 E	25 kN	500 t	5 t	2600 mm 2200 mm 1500 mm	
	3.500 E	35 kN	700 t	6 t	2600 mm 2200 mm 1500 mm	
	5.500 E	55 kN	1100 t	11 t	3500 mm 2200 mm 1500 mm	
	10.000 E	100 kN	2000 t	20 t	4200 mm 2200 mm 2200 mm	

Line LOK	Model	Draw Bar Pull *	Max Towing Capacity **	Weight	Dimensions LxWxH	Rail road
CRAB 5000E						
Draw Bar Pull - 11,240lbf						
Max tow capacity - 2,205,000 lbs						
Weight - 18,000 lbs						
Dimensions Rail Mode						
Length - 3850mm (151.5")						
Width - 2200mm (86.6")						
Height - 2650mm (104.3")						
	20.500	200 kN	4000 t	35 t	7000 mm 2500 mm 3630 mm	
	20.450	200 kN	4000 t	35 t	7000 mm 2500 mm 3630 mm	
	22.520	230 kN	4600 t	40 t	7000 mm 2500 mm 3630 mm	
	30.520	280 kN	5600 t	48 t	7360 mm 2500 mm 3660 mm	

Line LOKOM	Model	Draw Bar Pull *	Max Towing Capacity **	Weight	Dimensions LxWxH	Rail only
	LOKOM	From 70 kN to 120 kN	From 1400 t to 2400 t	From 18 t to 44 t	upon request	

Line INDUSTRIAL TRACTOR	Model	Draw Bar Pull *	Max Towing Capacity **	Weight	Dimensions LxWxH	Road
	650 NC	45 kN	129 t	6,7 t	3500 mm 1900 mm 2190 mm	
	650 NC 4x4	64 kN	183 t	8 t	3500 mm 1900 mm 2280 mm	
	800 NC	70 kN	200 t	11 t	3950 mm 2200 mm 2500 mm	
	800 NC 4x4	90 kN	257 t	11,5 t	3950 mm 2200 mm 2750 mm	

DIESEL RANGE APPLICATIONS



MINING - AUSTRALIA



INTERMODAL - ITALY



CHEMICAL INDUSTRY - SPAIN



PORT - GREECE



METRO - INDIA



RAILWAY - LITHUANIA



RAIL PASSENGER - SAUDI ARABIA



LOGISTIC - FINLAND



CARGO - KAZAKHSTAN



Rubber tire drive

- The rubber tire drive provides a uniform 100% tractive force with a single coupling in forward and reverse direction.
- The rubber tire drive system does not require extra weight to be added in order to provide enough traction.
- Traction tires don't wear the railways like metal wheels. Our equipment is lighter, so there is no added stress on the rail due to the weight, and the rubber last longer.
- The equipment is designed to not transfer extra force to the railcars or locomotives.

Design

Since 1969, Zephir has designed and manufacture bi-modal vehicles "railcar shunting locomotives" to efficiently, economically, and safely move our rail cars in a wide range applications areas.

Bimodal operation

The locotractor can be moved on or off track in most areas and in one quick and easy operation. It can cross paved tracks to move across rail yards quickly and efficiently.

Concept

The Locotractor traction system utilizes Rubber on Steel which produces twice the coefficient of traction compared to conventional Steel on Steel, independent from the rail condition.

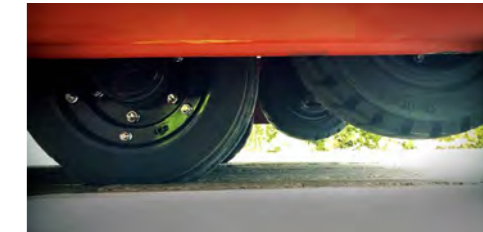

Coefficient of friction (Rubber Vs. Steel)

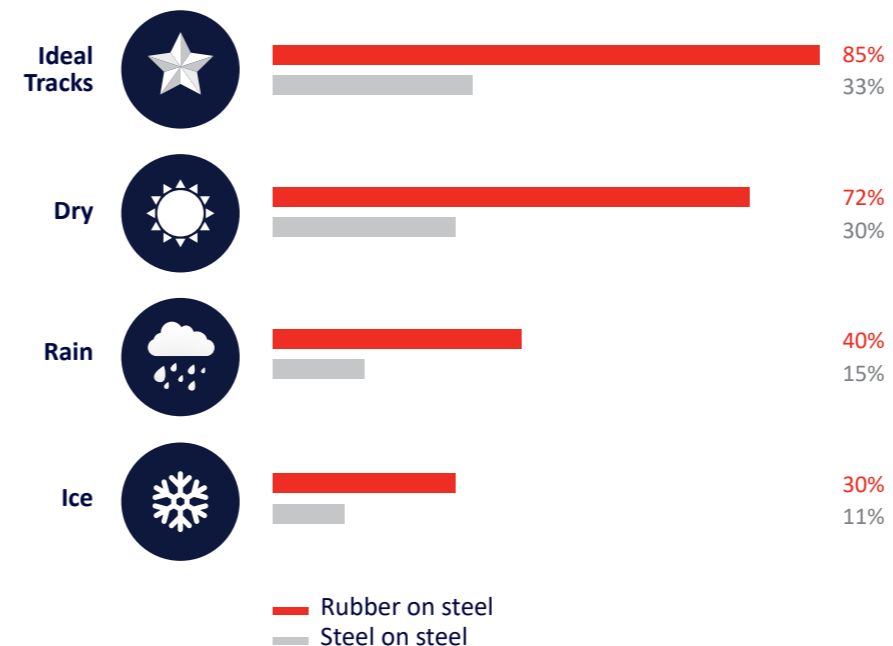

Easy to maintain and to operate

- Our machines are designed to be easily maintained with no special skills or tools needed.
- Anyone capable of operating basic equipment can drive the locotractor.
- Decrease labor costs and increase productivity because just one operator is needed to drive the locotractor.
- With compact dimensions, the locotractor is easy to transport and relocate.
- No need for special infrastructure or tools for service and maintenance Environmentally friendly.

SPECIAL AND CUSTOM MACHINES

LOK 1400 - 2000 - 2500



Military Applications



4 Wheel Steering System





ZEPHIR
 RAILROAD SHUNTING
 LOCOMOTIVES

ZEPHIR SpA
 Via Salvador Allende, 85
 41122 Modena - Italy
 Phone: +39 059 252554
 Fax +39 059 253759
 e-mail: zephir@zephir.eu
www.zephir.eu





U.S. Department of
Transportation

**Federal Highway
Administration**

FHWA-HEP-06-015
DOT-VNTSC-FHWA-06-02
NTIS No. PB2006-109012

FHWA HIGHWAY CONSTRUCTION NOISE HANDBOOK

Final Report
August 2006

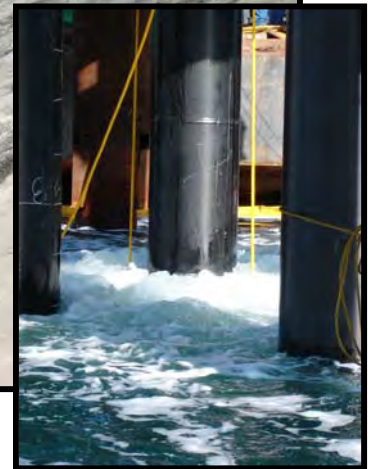

Prepared for:
U.S. Department of Transportation
Federal Highway Administration
Office of Natural and Human Environment
Washington, D.C. 20590

Prepared by:
U.S. Department of Transportation
Research and Innovative Technology Administration
John A. Volpe National Transportation Systems Center
Environmental Measurement and Modeling Division, Acoustics Facility
Cambridge, MA 02142

9.4 Summaries of Referenced Inventories

Included below are examples of several inventories of construction-related noise emission values. These and additional inventories are included on the companion CD-ROM.

9.4.1 RCNM Inventory

Equipment and operation noise levels in this inventory are expressed in terms of L_{max} noise levels and are accompanied by a usage factor value. They have been recently updated and are based on extensive measurements taken in conjunction with the Central Artery/Tunnel (CA/T) Project. Table 9.1 summarizes the equipment noise emissions database used by the CA/T Project. While these values represent the “default” values for use in the RCNM, user-defined equipment and corresponding noise levels can be added.

Table 9.1 RCNM Default Noise Emission Reference Levels and Usage Factors.

Equipment Description	Impact Device?	Acoustical Usage Factor (%)	Spec. 721.560 L_{max} @ 50 feet (dBA, slow)	Actual Measured L_{max} @ 50 feet (dBA, slow) (Samples Averaged)	Number of Actual Data Samples (Count)
All Other Equipment > 5 HP	No	50	85	N/A	0
Auger Drill Rig	No	20	85	84	36
Backhoe	No	40	80	78	372
Bar Bender	No	20	80	N/A	0
Blasting	Yes	N/A	94	N/A	0
Boring Jack Power Unit	No	50	80	83	1
Chain Saw	No	20	85	84	46
Clam Shovel (dropping)	Yes	20	93	87	4
Compactor (ground)	No	20	80	83	57
Compressor (air)	No	40	80	78	18
Concrete Batch Plant	No	15	83	N/A	0
Concrete Mixer Truck	No	40	85	79	40
Concrete Pump Truck	No	20	82	81	30
Concrete Saw	No	20	90	90	55
Crane	No	16	85	81	405
Dozer	No	40	85	82	55
Drill Rig Truck	No	20	84	79	22
Drum Mixer	No	50	80	80	1
Dump Truck	No	40	84	76	31
Excavator	No	40	85	81	170
Flat Bed Truck	No	40	84	74	4
Front End Loader	No	40	80	79	96
Generator	No	50	82	81	19
Generator (<25KVA, VMS Signs)	No	50	70	73	74
Gradall	No	40	85	83	70
Grader	No	40	85	N/A	0
Grapple (on backhoe)	No	40	85	87	1

Equipment Description	Impact Device?	Acoustical Usage Factor (%)	Spec. 721.560 L _{max} @ 50 feet (dBA, slow)	Actual Measured L _{max} @ 50 feet (dBA, slow) (Samples Averaged)	Number of Actual Data Samples (Count)
Horizontal Boring Hydraulic Jack	No	25	80	82	6
Hydra Break Ram	Yes	10	90	N/A	0
Impact Pile Driver	Yes	20	95	101	11
Jackhammer	Yes	20	85	89	133
Man Lift	No	20	85	75	23
Mounted Impact Hammer (hoe ram)	Yes	20	90	90	212
Pavement Scarifier	No	20	85	90	2
Paver	No	50	85	77	9
Pickup Truck	No	40	55	75	1
Pneumatic Tools	No	50	85	85	90
Pumps	No	50	77	81	17
Refrigerator Unit	No	100	82	73	3
Rivit Buster/Chipping Gun	Yes	20	85	79	19
Rock Drill	No	20	85	81	3
Roller	No	20	85	80	16
Sand Blasting (single nozzle)	No	20	85	96	9
Scraper	No	40	85	84	12
Sheers (on backhoe)	No	40	85	96	5
Slurry Plant	No	100	78	78	1
Slurry Trenching Machine	No	50	82	80	75
Soil Mix Drill Rig	No	50	80	N/A	0
Tractor	No	40	84	N/A	0
Vacuum Excavator (Vac-Truck)	No	40	85	85	149
Vacuum Street Sweeper	No	10	80	82	19
Ventilation Fan	No	100	85	79	13
Vibrating Hopper	No	50	85	87	1
Vibratory Concrete Mixer	No	20	80	80	1
Vibratory Pile Driver	No	20	95	101	44
Warning Horn	No	5	85	83	12
Welder/Torch	No	40	73	74	5

For each generic type of equipment listed in Table 9.1, the following information is provided:

- an indication as to whether or not the equipment is an impact device;
- the acoustical usage factor to assume for modeling purposes;
- the specification “Spec” limit for each piece of equipment expressed as an L_{max} level in dBA “slow” at a reference distance of 50 foot from the loudest side of the equipment;
- the measured “Actual” emission level at 50 feet for each piece of equipment based on hundreds of emission measurements performed on CA/T work sites; and
- the number of samples that were averaged together to compute the “Actual” emission level.

A comparison of the “Spec” emission limits against the “Actual” emission levels reveals that the Spec limits were set, in general, to realistically obtainable noise levels based on the equipment used by contractors on the CA/T Project. When measured in the field, some equipment such as pile drivers, sand

***SOUND STUDY FOR THE
TLA HOLBROOK, LLC TRANSFER STATION
HOLBROOK, MASSACHUSETTS***

January 2017

**SOUND STUDY FOR THE
TLA HOLBROOK, LLC
TRANSFER STATION
HOLBROOK, MASSACHUSETTS**

Prepared for:

TLA Holbrook, LLC
40 Shawmut Road – Suite 200
Canton, MA 02021-1409

Prepared by:

Tech Environmental, Inc.
303 Wyman Street
Suite 295
Waltham, MA 02451

January 3, 2017

TABLE OF CONTENTS

<u>Section</u>	<u>Contents</u>	<u>Page</u>
1.0	EXECUTIVE SUMMARY	1
2.0	COMMON MEASURES OF COMMUNITY NOISE	7
3.0	NOISE REGULATIONS	10
3.1	Massachusetts DEP Noise Policy	10
3.2	Holbrook Noise Bylaw	11
4.0	PRE-CONSTRUCTION SOUND LEVEL MEASUREMENTS	12
5.0	SOUND SOURCES	17
6.0	CALCULATED FUTURE SOUND LEVELS	19
6.1	Acoustic Modeling of Facility Operations.....	19
6.2	Acoustic Modeling of Vehicles on the Site	25
6.3	Acoustic Modeling of Equipment Backup Alarms.....	26
6.4	Rail Yard Operations	28
7.0	CONCLUSIONS	31
APPENDIX A	BASELINE SOUND LEVEL MEASUREMENTS	
APPENDIX B	ACOUSTIC MODELING RESULTS	

LIST OF TABLES AND FIGURES

List of Tables

<u>Table</u>	<u>Description</u>	<u>Page</u>
1	Subjective Effect of Changes in Sound Pressure Levels.....	7
2	Common Sound Levels.....	9
3	Daytime Baseline Sound Level Measurements	15
4	Evening Baseline Sound Level Measurements	16
5	Summary of Daytime Maximum Sound Levels at the Closest Noise Sensitive Areas	21
6	Summary of Evening Maximum Sound Levels at the Closest Noise Sensitive Areas	22
7	Predicted Future Truck Traffic Sound Levels at the Closest Noise Sensitive Areas	26
8	Comparison of Predicted Equipment Safety Alarm Sound Levels to Existing Daytime Sound Levels at the Closest Noise Sensitive Areas	27
9	Comparison of Predicted Equipment Safety Alarm Sound Levels to Existing Evening Sound Levels at the Closest Noise Sensitive Areas	28
10	Rail Yard Sound Levels (dBA)	29
11	Predicted Future Facility & Rail Yard Sound Levels at the Closest Residences	30

List of Figures

<u>Figure</u>	<u>Description</u>	<u>Page</u>
1	Monitoring and Modeling Receptor Locations.....	14
2	Maximum Daytime Project Sound Levels	23
3	Maximum Evening Project Sound Levels	24

1.0 EXECUTIVE SUMMARY

The objective of this study is to determine whether the operation of the TLA Holbrook, LLC's proposed municipal solid waste ("MSW") transfer station (the "Facility"), including the MSW transfer building (the "Building") on 3 Phillips Road in Holbrook, Massachusetts (the "Site") will comply with the Massachusetts Department of Environmental Protection (MassDEP) Noise Policy.

Since the November 2012 Sound Study, the following changes to the Project have occurred:

- The Building size has decreased from 27,331 square foot (sf) to approximately 22,300 sf.
- The truck entrances into the Building are moved from the south side of the Building to the north side of the Building and the turnaround area is eliminated on the south side of the Building.
- The Site access and egress for all haul trucks will be through a single road with side-by-side weigh stations instead of a separate access and egress roads in the original site plan.
- All haul trucks will proceed onto the Site and then back into the three entrances to the Building.
- The Building's fourth door opening [northwestern corner] will be used for railcar and/or live floor trailer access so that the waste may be loaded and transported off-site.
- Waste will not be baled prior to being placed into rail cars; thus, the telehandler and baler have been removed as sound sources in the transfer station.

Other changes in the noise impact analyses include:

- An updated traffic noise modeling analysis based on a hypothetical worst-case peak hour truck traffic volumes.
- A rail yard noise impact analysis is added to provide context for the potential sound conditions for nearby noise-sensitive receptors.
- An eastern property line receptor is added to the MassDEP noise impact analysis.
- The backup alarm noise analysis was updated to evaluate haul trucks backing up into the transfer station.

The Facility consists of the construction of the new 22,300 sf Building along with a rail yard, office building, scale house, warehouse with associated parking areas, underground utilities, stormwater controls and grading. The Site was previously operating as a chemical company that went out of business in 1998. Falvey Steel Castings, Inc. has occupied a building and outdoor storage space on the Site for the sale and storage of metal castings, while approximately 75% of the Site has remained vacant. The Facility will be located on eleven acres of Town-owned land that is leased by TLA Holbrook, LLC from the Town of Holbrook. The Facility will handle a maximum of 1,000 tons per day (tpd) of MSW. The proposed Facility will accept residential and municipal solid waste delivered by truck from haulers for sorting and transfer onto rail cars for transport to various locations throughout the country for disposal. The Building has been sized so that all unloading, handling, and loading onto rail cars and/or trucks will occur within the Building interior. The solid waste will be unloaded on the Building's interior tipping floor area where it will be properly handled and moved to a loading area to be loaded onto rail cars and/or trucks for transport off-site. A waste drop-off area and parking area where residents of the Town of Holbrook can unload normal household residential waste, recyclables, yard waste and certain large bulky items will be located in the northern portion of the Site.

The first step was to measure sound levels at locations near the Site to document the existing acoustic environment prior to construction of the proposed project. The second step was to use the Cadna-A acoustic model, based on International Standard ISO 9613, to calculate the sound levels from Facility operations and the Federal Highway Administration (FHWA) Traffic Noise Model (TNM), Version 2.5 for truck deliveries to the Site. The calculated sound levels at the boundary of the Site and nearby noise-sensitive receptors were then compared with limits in the MassDEP Noise Policy for Facility operation, and with FHWA noise guidelines for truck deliveries. The third step was to model sound impacts from haul trucks (inbound and outbound) and a track mobile rail car mover backup alarms, and rail yard activities. These noise impact analyses were performed to provide context for the potential sound conditions for nearby noise-sensitive receptors, since they are not regulated by MassDEP.

Baseline sound level monitoring was conducted at six locations representative of the nearby residential areas. Daytime sound level measurements were taken from 2:00 p.m. to 5:00 p.m. on

September 20, 2012. Evening sound level measurements were taken from 7:00 p.m. to 10:00 p.m. on September 25, 2012. The six monitoring locations were: 1) a residence at 48 Water Street, Holbrook; 2) a residence at 20 Water Street, Holbrook; 3) a residence at 364 Center Street, Randolph; 4) the Holy Tabernacle Church of Randolph at 333 Center Street, Randolph, which is near the west property line of the project; 5) a residence at 15 Englewood Avenue East, Randolph; and 6) at the long term monitoring location on the northern property line of the Site. The principal daytime sounds at these locations are traffic on Route 138 and other nearby roads, activities in the surrounding industrial area and natural sounds.

The potential sounds from the Facility are:

- Mechanical equipment and waste tipping inside the Building, the sound from which will reach the outside environment through building walls and door openings.
- Truck deliveries to and from the Site (240 trips per day) along a route from Route 138 into the site and back.
- The removal of MSW on rail cars or live floor trailers to be transported to various locations throughout the country for disposal.

MassDEP Noise Policy regulates sound from mechanical equipment operation on the Site. The MassDEP does not regulate sound from motor vehicles accessing the Site or the equipment backup notification alarms as required by the Occupational Safety and Health Administration (OSHA). The sound from truck deliveries to and from the Site are not regulated by federal, state or local regulations other than U.S. Environmental Protection Agency (EPA) limits on the sound from individual trucks, imposed at the point of manufacture. In addition, rail yard activities are also exempt from the MassDEP Noise Policy other than EPA limits established for both locomotive operations under stationary conditions and under moving conditions, and rail car coupling operations.

The Cadna-A acoustic modeling assumed simultaneous operation of all equipment, with three of the four rollup doors closed in the Building. Although doors will be closed to the extent practical, Tech modeled the data based on the assumption that one door remained open throughout the workday to create a conservative analysis. The modeling results demonstrate full compliance with the MassDEP

Noise Policy. Maximum Facility daytime sound at the nearest noise-sensitive receptors will be 43 to 54 dBA, as compared to the lowest L₉₀ background levels of 48 to 51 dBA, and will increase the lowest background sound levels by 1 to 6 dBA at the nearest noise-sensitive receptors. Maximum Facility evening sound at the nearest noise-sensitive receptors will be 42 to 50 dBA, as compared to the lowest L₉₀ background levels of 40 to 49 dBA, and will increase the lowest background sound levels by only 1 to 5 dBA. Maximum sound levels from the Facility in residential areas will be less than 50 dBA and 45 dBA during the daytime and evening, respectively and will be inaudible to slightly noticeable at all nearby noise-sensitive receptors.

Truck traffic traveling on Water Street into the Site was modeled using the Federal Highway Administration (FHWA) Traffic Noise Model (TNM), Version 2.5. The results of the traffic noise modeling were compared to the FHWA residential noise abatement criterion of 66 dBA and Massachusetts Department of Transportation's (MassDOT) significant threshold of 10 dBA or greater than existing noise levels. To be ultra-conservative in our analysis, the artificially inflated worst-case peak morning and afternoon truck trips of 103 and 59 trips, respectively were used.¹ These volumes were based on the Allied/Peabody numbers, which are more than seven times the truck trips for the morning peak hour and more than four the truck trips for the afternoon peak hour estimated for the Facility. The peak morning truck trips were used in this traffic noise analysis.

The purpose of the truck traffic noise impact analysis is to provide context for the potential sound conditions for locations along the truck haul route since MassDEP does not regulate noise from truck traffic. The potential sound levels are below the 66 dBA FHWA criterion at all locations, except for 48 Water Street. Under this very conservative worst-case peak morning traffic hour, the predicted sound level is 69 dBA, which is 3 dBA above the FHWA criterion. However, the incremental increase in truck traffic sound at this receptor location is zero when compared to the existing daytime sound level. Therefore, the development of the Facility does not impact sound intensity at this location. The incremental change in sound levels at all other receptor locations are below the MassDOT 10-dBA significance threshold. Even under this hypothetical worst-case peak hour of

¹Beveridge & Diamond, Motion for Reconsideration and to Reopen Record Application No. BWP-SW-01 Site Suitability Report for a New Site Assignment Transmittal No. X254488 Site Suitability Report No. 133-003-A, September 24, 2015, p. 14.

truck trips, only one location is above the FHWA 66-dBA criterion and the incremental change in existing noise levels is zero.

The sound from truck and equipment safety alarms (backup alarms) is exempt from state and local regulation (see Section 3.0). The design of the transfer station will require haul trucks to back into the Building triggering backup alarms from haul trucks. These backup alarm sounds would occur during the daytime (6:00 a.m. to 6:00 p.m.). In addition, the track mobile rail car mover will be used to move rail cars from the Building to the rail yard intermittently throughout the Facility's operational day (6:00 a.m. to 10:00 p.m.).

The sound levels at the nearest residences were predicted using the Cadna-A model. The predicted sound levels at the nearest residential receptors range from 46 to 51 dBA, as shown in Table 8, and are equal to or 1 dBA above existing daytime L₉₀ sound levels at all locations. During the evening hours, the track mobile rail car mover would be the only piece of equipment operating outdoors that would have a backup alarm. The predicted sound levels at the nearest residential receptors range from 45 to 47 dBA, and are equal to or 1 dBA above existing evening L₉₀ sound levels at all locations. Therefore, the backup alarm will sometimes be slightly audible during the day and evening in certain residential areas. This is a typical circumstance for residences that abut industrial areas, similar to the project site.

The MassDEP does not regulate sound from locomotives and rail cars accessing the site. EPA regulates railroad emissions standards under 40 CFR 201: *Noise Emission Standards for Transportation Equipment: Interstate Rail Carriers*. Nonetheless, a rail yard noise analysis was performed to provide context for the potential sound conditions for nearby noise-sensitive receptors.

For the purposes of providing context of the potential sound impacts from the rail yard, the following sound sources were assumed to be operating in the rail yard: rail car coupling, a switch engine, an idling locomotive and a locomotive moving rail cars in the yard. The total late night noise level increases will be 4 dBA or less. A sound level increase of 4 dBA is considered a perceptible to noticeable change in sound. This nighttime locomotive activity will be similar to the current active rail line adjacent to the Site.

In conclusion, the proposed Facility will fully comply with the MassDEP Noise Policy and it will not create a nuisance in nearby residential areas in Holbrook and Randolph. In order to ensure that sound levels from the Facility will comply with the MassDEP Noise Policy, the Building will be operated so that roll-up doors are kept closed except when it is necessary for a truck or rail car to enter or leave the building, and a two-sided wall will be constructed around the waste compactor in the residential recycling area. Based on these analyses and our experience at other similar facilities, the Facility as proposed will not cause an adverse impact to health, safety or the environment with respect to noise.

2.0 COMMON MEASURES OF COMMUNITY NOISE

The unit of sound pressure is the decibel (dB). The decibel scale is logarithmic to accommodate the wide range of sound intensities to which the human ear is subjected. A property of the decibel scale is that the sound pressure levels of two separate sounds are not directly additive. For example, if a sound of 70 dB is added to another sound of 70 dB, the total is only a 3-decibel increase (or 73 dB), not a doubling to 140 dB. Thus, every 3 dB increase represents a doubling of sound energy. For broadband sounds, a 3 dB change is the minimum change perceptible to the human ear. Table 1 below gives the perceived change in loudness of different changes in sound pressure levels.²

TABLE 1
SUBJECTIVE EFFECT OF CHANGES IN SOUND PRESSURE LEVELS

CHANGE IN SOUND LEVEL	APPARENT CHANGE IN LOUDNESS
3 dB	Just perceptible
5 dB	Noticeable
10 dB	Twice (or half) as loud

Non-steady noise exposure in a community is commonly expressed in terms of the A-weighted sound level (dBA); A-weighting approximates the frequency response of the human ear. Levels of many sounds change from moment to moment. Some are short, lasting 1 second or less, while others rise and fall over much longer periods of time. There are various measures of sound pressure designed for different purposes. To establish the background ambient sound level in an area, the L_{90} metric, which is the sound level exceeded 90 percent of the time, is typically used. The L_{90} can also be thought of as the level representing the quietest 10 percent of any time period. This is a broadband sound pressure measure, i.e., it includes sounds at all frequencies. The L_{eq} , or equivalent sound level, is the steady-state sound level over a period of time that has the same acoustic energy as the fluctuating sounds that actually occurred during that same period. It is commonly referred to as the average sound level. The

²American Society of Heating, Refrigerating and Air Conditioning Engineers, Inc., 1989 ASHRAE Handbook-- Fundamentals (I-P) Edition, Atlanta, GA, 1989.

L_{max} , or maximum sound level, represents the one second peak level experienced during a given time period.

Sound level measurements typically include an analysis of the sound spectrum into its various frequency components to determine tonal characteristics. The unit of frequency is Hertz (Hz), measuring the cycles per second of the sound pressure waves, and typically the frequency analysis examines eleven octave bands from 16 to 16,000 Hz. MassDEP Noise Policy states that a source creates a pure tone if acoustic energy is concentrated in a narrow frequency range and one octave band has a sound level 3 dB greater than both adjacent octave bands.

The acoustic environment in a suburban area such as Holbrook and Randolph results from numerous sources and the major source is motor vehicle traffic on local roadways and industrial sources around the Site. Typical sound levels associated with various activities and environments are presented in Table 2.

TABLE 2
COMMON SOUND LEVELS

Sound Level (dBA)	Common Indoor Sounds	Common Outdoor Sounds
110	Rock Band	Jet Takeoff at 1000'
100	Inside NYC Subway Train	Chain Saw at 3'
90	Food Blender at 3'	Impact Hammer (Hoe Ram) at 50'
80	Garbage Disposal at 3'	Diesel Truck at 100'
70	Vacuum Cleaner at 10'	Lawn Mower at 100'
60	Normal Speech at 3'	Auto (40 mph) at 100'
50	Dishwasher in Next Room	Busy Suburban Area at night
40	Empty Conference Room	Quiet Suburban Area at night
25	Empty Concert Hall	Rural Area at night

3.0 NOISE REGULATIONS

3.1 Massachusetts DEP Noise Policy

MassDEP regulates noise through 310 CMR 7.10, "Air Pollution Control". In these regulations "air contaminant" is defined to include sound and a condition of "air pollution" includes the presence of an air contaminant in such concentration and duration as to "cause a nuisance" or "unreasonably interfere with the comfortable enjoyment of life and property".

Regulation 7.10 prohibits "unnecessary emissions" of noise. The MassDEP Noise Policy (Policy Statement 90-001, February 1, 1990) interprets a violation of this noise regulation to have occurred if the source causes either:

- 1) An increase in the broadband sound pressure level of more than 10 dBA above the ambient, or
- 2) A "pure tone" condition.

The ambient background level is defined as the lowest L_{90} level measured during facility operating hours. The Facility will operate 6:00 a.m. to 10:00 p.m., Monday – Saturday. A "pure tone" condition occurs when any octave band sound pressure level exceeds both of the two adjacent octave band sound pressure levels by 3 dB or more. The limits are applied at the nearest residence and residential property line. MassDEP routinely grants a waiver from the 10-dBA incremental limit on industrial property lines where there is no nearby sensitive receptor, as is the case for the eastern and southern property lines closest to the Site.

The MassDEP does not regulate sound from motor vehicles accessing the Site or the equipment backup notification alarms as required by the Occupational Safety and Health Administration (OSHA). Therefore, the provisions described above only apply to a portion of the sources that may generate sound during the operation of the proposed Facility. Federal law pre-empts state and local governments from regulating the sound of trucks making deliveries to a commercial site under the federal Noise Control Act of 1972 and the Surface Transportation Assistance Act of 1982.

Similarly, MassDEP also does not regulate sound from locomotives and rail cars accessing the Site. Federal law pre-empts state and local governments from regulating sound from locomotives and rail cars by setting noise emissions limits on rail yards. The U.S. Environmental Protection Agency (EPA) regulates railroad emissions standards under 40 CFR 201: *Noise Emission Standards for Transportation Equipment: Interstate Rail Carriers*.

3.2 Holbrook Noise Bylaw

The Town of Holbrook Zoning Bylaw does not contain any noise regulation with decibel limits applicable to the Facility .

4.0 PRE-CONSTRUCTION SOUND LEVEL MEASUREMENTS

The Facility will be located in a planned industrial area of Holbrook. The objective of this part of the study was to establish the existing baseline ambient sound levels in the community for use in Facility design, compliance assessment and mitigation analysis. The principal sources of future sound will be three pieces of diesel-powered equipment inside the Building, roof top ventilation fans and three pieces of diesel-powered equipment outside the Building during normal operating conditions (Monday through Saturday, 6:00 a.m. to 10:00 p.m.). To identify the lowest L_{90} background level during Facility operating hours, daytime baseline measurements were made at five locations between 2:00 p.m. and 5:00 p.m. on a weekday, and evening baseline measurements were made at the same five locations between 7 p.m. and 10 p.m. on a weekday. A long-term sound analyzer was also placed at the north property line of the Site to measure hourly sound levels over a five-day period that included a weekend to provide a complete picture of 24-hour sound conditions at the site. The six measurement locations were as follows:

- R1: Residence at 48 Water Street, Holbrook
- R2: Residence at 20 Water Street, Holbrook
- R3: Residence at 364 Center Street, Randolph
- PL2: : Site's Western Property Line
- R5: Residence at 15 Englewood Avenue East, Randolph
- PL1: Location of Long Term Meter / Site's Northern Property Line

Weather conditions were acceptable for accurate ambient sound level measurements during the daytime hours of Thursday, September 20, 2012 and evening hours of Tuesday, September 25, 2012. On September 20, 2012, skies were sunny, temperatures were 60° to 68° F, and the wind speed was in the range of 0 to 8 mph. On September 25, 2012, skies were clear with no precipitation, temperatures were 60° to 64° F, and the wind speed was in the range of 3 to 6 mph. The dominant sources of sound observed at the six locations, were as follows:

- 1) Distant roadway traffic, periodic aircraft overhead and natural sounds (insects).
- 2) Steady roadway traffic on nearby Route 138 (Union Street), Central Street and South Street.
- 3) Commuter rail train and surrounding industrial area activities.

All short-term measurements were taken with a Bruel and Kjaer 2250 real-time sound analyzer and the long-term measurements were taken with a Larson Davis 824 real-time sound level analyzer. Both analyzers are equipped with a 1/2" precision condenser microphone and have an operating range of 5 dB to 140 dB, and an overall frequency range of 3.5 to 20,000 Hz. These analyzers meet or exceed all requirements set forth in the American National Standards Institute (ANSI) Standards for Type 1 for quality and accuracy. Prior to and immediately following both measurement sessions, the sound analyzers were calibrated (no level adjustment was required) with an ANSI Type 1 calibrator which has an accuracy traceable to the National Institute of Standards and Technology (NIST). All instrumentation was laboratory calibrated per ANSI recommendations. For all measurement sessions, the microphones were fitted with an environmental windscreen to negate the effect of air movement and tripod-mounted at a height of five feet. Measurements were completed in open areas away from vertical reflecting surfaces. All data were downloaded to a computer following the measurement session for the purposes of storage and further analysis, and a summary of the data are provided in Appendix A.

Figure 1 shows the sound monitoring locations. A summary of the baseline measurements is provided in Tables 3, and 4. At the six monitoring locations, background (L_{90}) levels range from 45 to 51 dBA during the day and from 44 to 47 dBA in the evening, average (L_{eq}) levels cover a wider range of 51 to 69 dBA during the day and from 48 to 64 dBA in the evening. The maximum (L_{max}) levels are 70 to 111 dBA during the day and from 56 to 109 dBA in the evening. A pure tone was measured at 4,000 Hz at 20 Water Street due to a vacuum from a nearby car wash during the daytime, and a pure tone was measured at 2,000 Hz at the Site's western property line due to insect activity.

Tables 3 and 4 also list the residential sound level limits under the MassDEP Noise Policy, namely $L_{90} + 10$ dBA. Continuous sound levels from the proposed facility may not exceed these levels.



Figure 1
Monitoring and Modeling Receptor Locations
TLA Holbrook Transfer Station
Holbrook, MA

TABLE 3

**DAYTIME BASELINE SOUND LEVEL MEASUREMENTS
HOLBROOK, MASSACHUSETTS**

September 20, 2012 – 2 p.m. to 5 p.m.

Sound Level Measurement	-R1- 48 Water St., Holbrook	-R2- 20 Water St., Holbrook	-R3- 364 Center Street, Randolph	-PL2- West Property Line¹	-R4- 15 Englewood Avenue, Randolph²	-PL1- North Property Line
Broadband (dBA)						
Background(L ₉₀)	47.7	45.0	51.0	48.8	49.8	48.5
Average (L _{eq})	69.3	50.6	68.8	59.3	61.2	57.4
Maximum (L _{max})	101.1	69.6	85.3	78.6	111.3	77.1
Octave Band L ₉₀ (dB)						
16 Hz	55.8	55.9	57.2	55.4	56.4	55.4
32 Hz	58.0	57.4	57.8	57.9	57.2	57.1
63 Hz	55.8	54.5	56.1	54.9	55.0	56.2
125 Hz	50.1	47.2	52.4	50.6	50.9	52.7
250 Hz	44.8	39.1	47.8	46.5	46.4	47.3
500 Hz	43.0	39.1	44.2	44.1	43.4	44.4
1000 Hz	43.3	39.1	46.9	44.3	45.6	43.8
2000 Hz	38.4	33.2	43.5	39.5	40.5	38.2
4000 Hz	33.5	36.5	36.7	35.9	38.8	36.1
8000 Hz	28.1	32.8	28.6	29.5	28.1	27.2
16000 Hz	14.7	17.3	16.7	16.4	15.3	16.3
Existing Pure Tone Condition?	No	Yes	No	No	No	No
MassDEP Noise Policy Limit (dBA)	57.7	55.0	61.0	58.8	59.8	58.5

¹PL2 was used to represent the Holy Tabernacle Church of Randolph (R5).

²R5 was used to represent the south property line of project site (PL3).

TABLE 4

**EVENING BASELINE SOUND LEVEL MEASUREMENTS
HOLBROOK, MASSACHUSETTS**

September 25, 2012 – 7 p.m. to 10 p.m.

Sound Level Measurement	-R1- 48 Water St., Holbrook	-R2- 20 Water St., Holbrook	-R3- 364 Center Street, Randolph	-PL2- West Property Line¹	-R4- 15 Englewood Avenue, Randolph²	-PL1- North Property Line
Broadband (dBA)						
Background(L ₉₀)	45.5	46.0	44.1	46.9	46.8	44.1
Average (L _{eq})	55.1	47.6	64.4	51.2	58.7	50.7
Maximum (L _{max})	78.5	56.0	81.8	71.7	109.0	74.0
Octave Band L ₉₀ (dB)						
16 Hz	48.4	49.0	50.4	47.1	47.5	46.6
32 Hz	50.8	50.5	51.6	49.2	51.0	48.6
63 Hz	51.2	49.9	52.9	50.0	51.1	49.1
125 Hz	46.6	44.5	47.4	46.3	45.1	44.9
250 Hz	40.4	39.4	41.2	38.8	42.5	38.8
500 Hz	39.8	37.1	37.3	38.0	38.7	37.3
1000 Hz	39.8	36.7	37.4	37.7	36.2	36.0
2000 Hz	39.3	40.2	37.3	43.4	41.9	37.8
4000 Hz	33.4	39.2	34.7	34.0	39.9	36.3
8000 Hz	27.1	26.3	22.9	20.1	25.1	23.1
16000 Hz	16.9	18.4	13.7	12.8	15.8	13.2
Existing Pure Tone Condition?	No	No	No	Yes	No	No
MassDEP Noise Policy Limit (dBA)	55.5	56.0	54.1	56.9	56.8	54.1

¹PL2 was used to represent the Holy Tabernacle Church of Randolph (R5).

²R5 was used to represent the south property line of project site (PL3).

5.0 SOUND SOURCES

The Building will have a total of four roll-up doors. Three roll-up doors on the north side for incoming haul trucks and one roll-up door for rail cars and/or live floor trailers to move in out of the Building. Truck deliveries to and pickups from the Site will total no more than 240 trips per day at design capacity. Up to two rail cars at a time will be loaded inside the Building with up to 10 to 12 rail cars being loaded per day.

The Building will have an average interior height of 40 feet, truck rollup door openings are assumed to be 15 feet wide by 30 feet high and the rail car roll-up door openings are assumed to be 25 feet wide by 30 feet high. The Building will be constructed of steel walls, steel roof and steel roll-up doors. The Building will be operated so that roll-up doors are kept closed except when it is necessary for a truck or rail car to enter or leave the building.

Sound sources included as part of the acoustic modeling analysis are:

- A skid steer, front-end loader and excavator operating inside the Building to move materials, operating continuously.
- Track mobile rail car mover outside the Building to move rail cars in the rail yard.
- Street sweeper outside the Building for sweeping the paved site access road.
- Building roof top ventilation fans.
- Waste compactor located at the residential recycling area.
- Haul truck idling inside the Building.

All of these, except for the roof top ventilation units, street sweeper and the waste compactor, will be inside Building. The track mobile rail car mover will operate primarily outside the Building, except for periodically moving rail cars into the Building. Ventilation fans and motors will be located inside the Building, in an enclosure, and air will be exhausted through vents on the roof. The fan sound will be insignificant compared to that from mechanical equipment inside the Building. Similarly, the sound of waste tipping onto the tipping floor is insignificant compared to that from

mechanical equipment inside the Building. The street sweeper will be used to minimize fugitive dust emissions from the paved Site access road and will be utilized on an as-needed basis. The waste compactor will be shielded on two sides to reduce sound levels for noise-sensitive receptors north and west of the Site.

The point source L_{\max} sound power levels (L_w) for each source used in the modeling are as follows:

- Loader: 110.7dBA
- Excavator: 112.7 dBA
- Heavy Truck Idling: 89.2 dBA
- Steer Skid: 110.7 dBA
- Street Sweeper: 111.7 dBA
- Track Mobile: 101.4 dBA
- Ventilation Fan: 92.5 dBA
- Waste compactor: 111.6 dBA

All sources were assumed to operate simultaneously in the acoustic modeling. Usage factors of 5 to 100% were used to represent the percentage of time the equipment operates at its maximum load were obtained from FHWA.³ For example, a usage factor of 40% were applied for the loader, excavator, truck idling and skid steer. Sound data for each piece of equipment were either based on literature reference data or sound measurements taken by Tech on other similar projects. Octave band details are given in Appendix B.

The Cadna-A model summed all interior sound sources from the proposed Building, and calculated the transmission of sound through the closed doorways and walls of the Building to the outdoors. It was assumed that all rollup doors closed. In other words, Tech's model assumed that one rollup door would be open at all times. All outdoor sound sources were then summed to determine the Facility's impacts (i.e. both MSW and non-MSW activities) for comparison to the MassDEP Noise Policy limits.

³ FHWA, Roadway Construction Noise Model User's Guide, January 2006.

6.0 CALCULATED FUTURE SOUND LEVELS

6.1 Acoustic Modeling of Facility Operations

Future maximum sound levels at the nearest residences, and at the Site's property lines, were calculated with the Cadna-A acoustic model assuming simultaneous operation of all regulated sound sounds at their maximum loads. Cadna-A is a sophisticated 3-D model for sound propagation and attenuation based on International Standard ISO 9613⁴. Atmospheric absorption is the process by which sound energy is absorbed by the air and was calculated using ANSI S1.26-1995.⁵ Absorption of sound assumed standard day conditions and is significant at large distances and at high frequencies. ISO 9613 was used to calculate propagation and attenuation of sound energy by hemispherical divergence with distance, surface reflection, ground, and shielding effects by barriers, buildings, and ground topography. Offsite topography was determined using official USGS digital elevation data for the study area.

As shown in Figure 1, future maximum sound levels were predicted at the same six locations where baseline sound level measurements were made:

- R1 - 48 Water Street, Holbrook
- R2 - 20 Water Street, Holbrook
- R3 - 364 Center Street, Randolph
- R5 - 15 Englewood Avenue, Randolph
- PL1 – Site's Northern Property Line
- PL2 – Site's Western Property Line

Sound levels were also predicted at three other Site property lines and one nearby sensitive receptor:

- R4 - 1 Holy Tabernacle Church of Randolph, Randolph
- PL3 – Site's Southern Property Line
- PL4 – Site's Eastern Property Line

⁴International Standard, ISO 9613-2, Acoustics – Attenuation of Sound During Propagation Outdoors, -- Part 2 General Method of Calculation.

⁵American National Standards Institute, ANSI S1.26-1995, American National Standard Method for the Calculation of the Absorption of Sound by the Atmosphere, 1995.

The results of these calculations, presented in Tables 5 and 6, demonstrate that the Facility will fully comply with the MassDEP Noise policy at all noise-sensitive locations. The Facility will increase the daytime background sound levels at the nearest residences by no more than 6 dBA and up to 9 dBA at the Site property line. The Facility will increase the evening background sound levels at the nearest residences by no more than 5 dBA and up to 10 dBA at the Site property line. The acoustic modeling calculations (see Appendix B) also confirm that the Facility will not create any pure tone nuisance conditions as described in the MassDEP Noise Policy. (Note that octave band results in Appendix B are un-weighted or linear decibels.)

Figures 2 and 3 shows color-coded decibel contours (5 feet above ground level) for the operation of all regulated sound sources of the Facility and their effects on the nearby areas. These contours display the maximum continuous sound levels for the Facility. The results in Figures 2 and 3 demonstrate compliance with the MassDEP Noise Policy at all nearby residential property lines and residences. Maximum sound levels from the Facility in residential areas will be less than 50 dBA and 45 dBA during the daytime and evening, respectively and will be inaudible to slightly audible at all nearby residences.

TABLE 5**SUMMARY OF DAYTIME MAXIMUM SOUND LEVELS
AT THE CLOSEST NOISE SENSITIVE AREAS**

Receptor Locations	Lowest Measured Background Sound Level (L₉₀) (dBA)	Predicted Maximum Sound Level from the Facility (dBA)	Total Predicted Sound Level (dBA)	Predicted Sound Level Increase (dBA)	Complies with MassDEP Noise Policy?
R1- 48 Water Street, Holbrook	47.7	45.7	49.8	2	Yes
R2- 20 Water Street, Holbrook	45.0	48.4	50.0	5	Yes
R3- 364 Center Street, Randolph	51.0	50.8	53.9	3	Yes
R4 - Holy Tabernacle Church, Randolph	48.8*	53.8	55.0	6	Yes
R5 - 15 Englewood Avenue, Randolph	49.8	42.5	50.5	1	Yes
PL1 – North Property Line	48.5	55.9	56.6	8	Yes
PL2 -West Property Line	48.8	57.5	58.0	9	Yes
PL3 – South Property Line	49.8	51.5	53.7	4	Yes
PL4 – East Property Line	48.5	56.1	56.8	8	Yes

* Estimated background level from measurements at a nearby, similar location.

TABLE 6**SUMMARY OF EVENING MAXIMUM SOUND LEVELS
AT THE CLOSEST NOISE SENSITIVE AREAS**

Receptor Locations	Lowest Measured Background Sound Level (L₉₀) (dBA)	Predicted Maximum Sound Level from the Facility (dBA)	Total Predicted Sound Level (dBA)	Predicted Sound Level Increase (dBA)	Complies with MassDEP Noise Policy?
R1- 48 Water Street, Holbrook	45.5	42.4	47.2	2	Yes
R2- 20 Water Street, Holbrook	46.0	42.3	47.5	2	Yes
R3- 364 Center Street, Randolph	44.1	46.7	48.6	5	Yes
R4 - Holy Tabernacle Church, Randolph	46.9*	50.3	51.9	5	Yes
R5 - 15 Englewood Avenue, Randolph	46.8	41.5	47.9	1	Yes
PL1 – North Property Line	44.1	50.9	51.7	8	Yes
PL2 -West Property Line	46.9	54.8	55.5	9	Yes
PL3 – South Property Line	46.8	51.4	52.7	6	Yes
PL4 – East Property Line	44.1	53.7	54.2	10	Yes

* Estimated background level from measurements at a nearby, similar location.

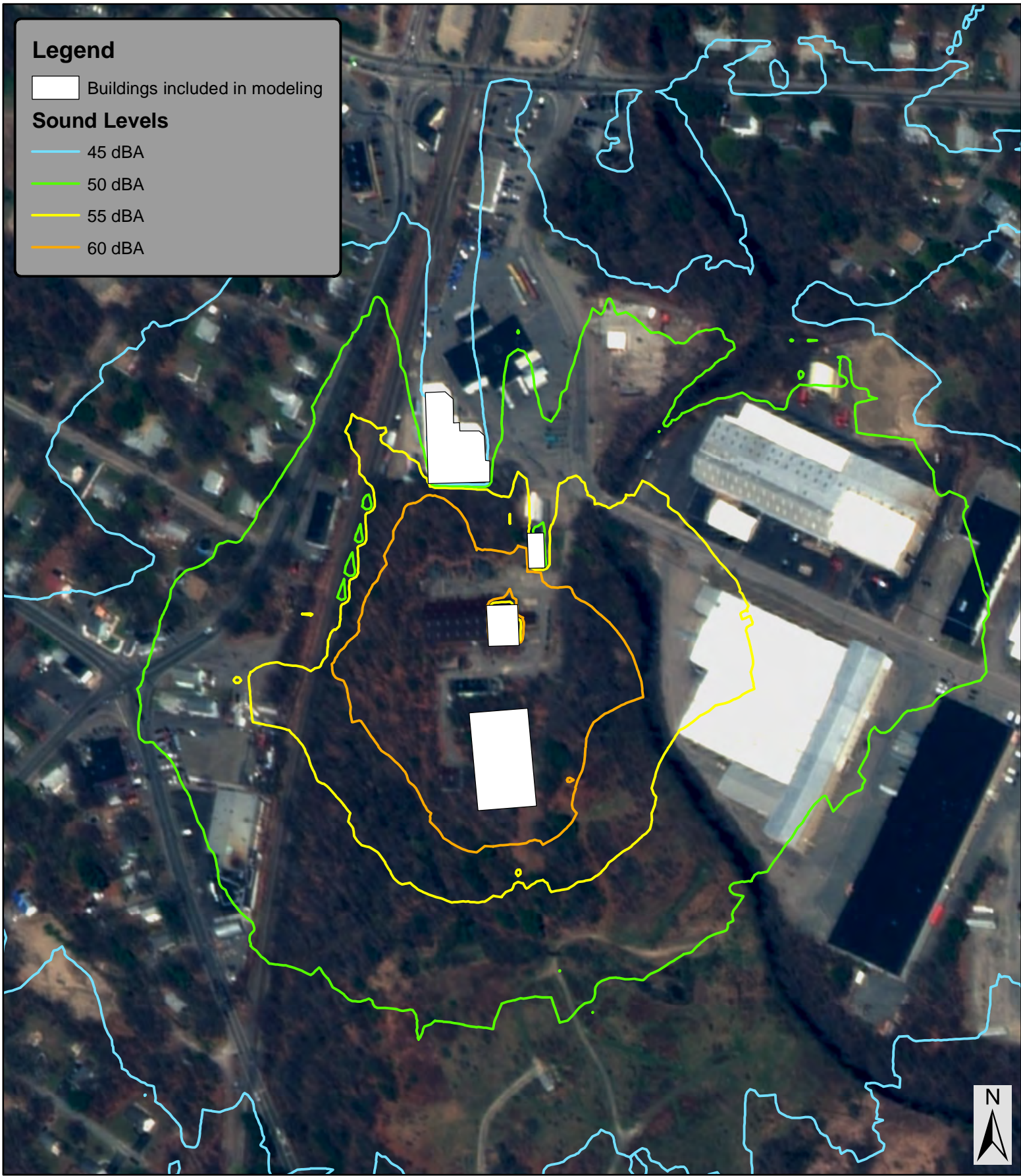

Legend

- Buildings included in modeling
- Sound Levels**
- 45 dBA
- 50 dBA
- 55 dBA
- 60 dBA

0 100 200 400 Feet

Figure 2
 Maximum Daytime Project Sound Levels (dBA)
 TLA Holbrook Transfer Station
 Holbrook, MA

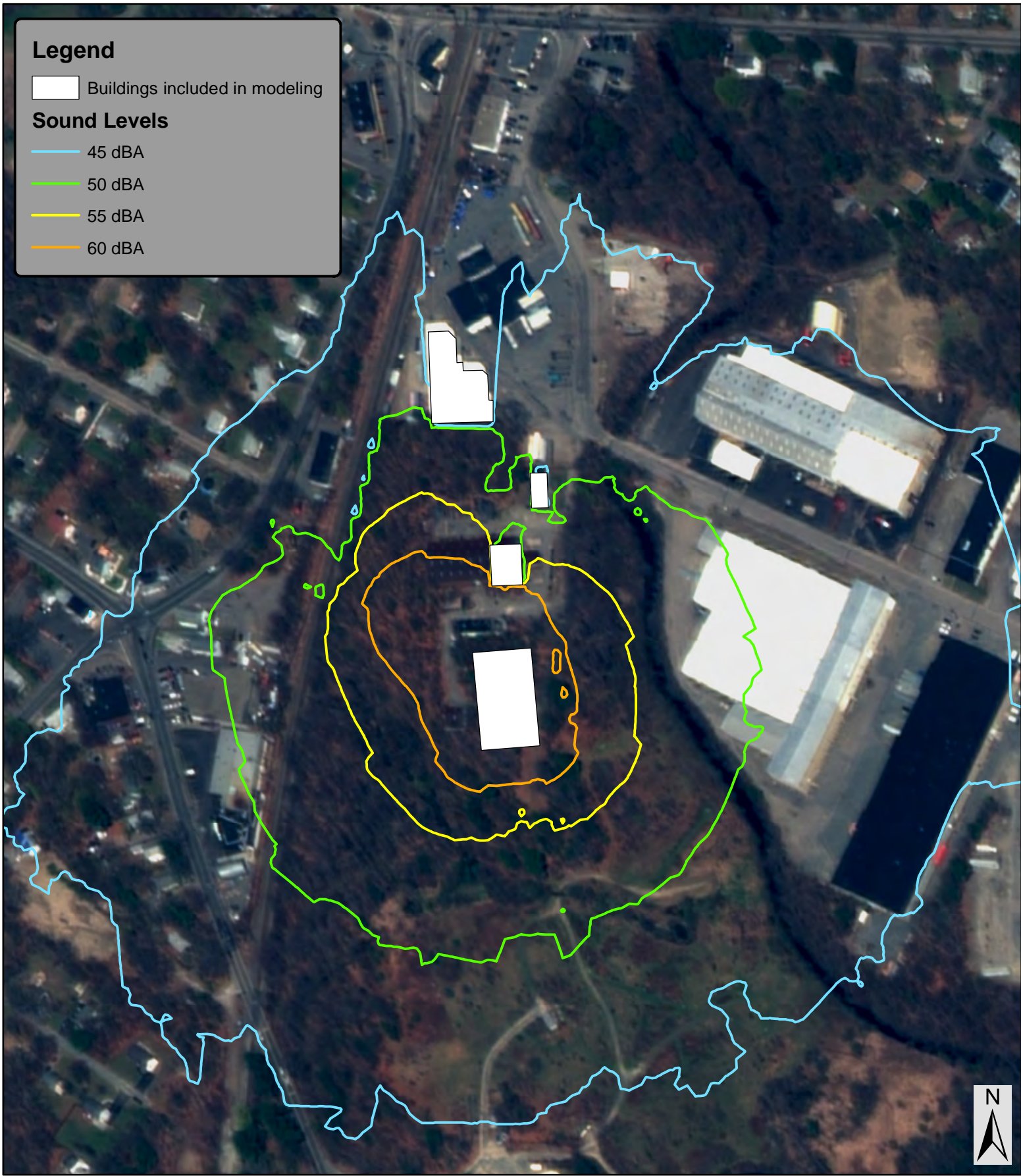

Legend

▭ Buildings included in modeling

Sound Levels

- 45 dBA
- 50 dBA
- 55 dBA
- 60 dBA

0 100 200 400 Feet



Figure 3
Maximum Evening Project Sound Levels (dBA)
TLA Holbrook Transfer Station
Holbrook, MA

6.2 Acoustic Modeling of Vehicles on the Site

Truck traffic traveling on Water Street into the Site was modeled using the Federal Highway Administration (FHWA) Traffic Noise Model (TNM), Version 2.5. The results of the traffic noise modeling were compared to the FHWA residential noise abatement criterion of 66 dBA⁶ and Massachusetts Department of Transportation's (MassDOT) significant threshold of 10 dBA or greater than existing noise levels.⁷ To be ultra-conservative in our analysis, the artificially inflated worst-case peak morning and afternoon truck trips of 103 and 59 trips, respectively were used. These volumes were based on the Allied/Peabody numbers, which are more than seven times the truck trips for the morning peak hour and more than four the truck trips for the afternoon peak hour estimated for the Facility. The peak morning truck trips were used in this traffic noise analysis.

The purpose of the truck traffic noise impact analysis is to provide context for the potential sound conditions for locations along the truck haul route since MassDEP does not regulate noise from truck traffic. Given that the Facility is not being funded by FHWA or MassDOT, a strict comparison to these standards is not required. Nonetheless, Table 7 presents a comparison to both the FHWA noise abatement criteria and the MassDOT significance increase threshold. The potential sound levels are below the 66 dBA FHWA criterion at all locations, except for 48 Water Street. Under this worst-case peak morning traffic hour, the predicted sound level is 69 dBA, which is 3 dBA above the FHWA criterion. However, the incremental increase in truck traffic sound at this receptor location is zero when compared to the existing daytime sound level. The incremental change in sound levels at all other receptor locations are below the MassDOT 10-dBA significance threshold. Even under this hypothetical worst-case peak hour of truck trips, only one location is above the inapplicable FHWA 66-dBA criterion and the incremental change in existing noise levels is zero.

⁶ 23 Code of Federal Regulations Part 772.

⁷ MassDOT, Type I and Type II Noise Abatement Policy and Procedures, July 13, 2011.

TABLE 7

**PREDICTED FUTURE FACILITY TRUCK TRAFFIC SOUND LEVELS
AT THE CLOSEST NOISE SENSITIVE AREAS (dBA)**

Receptor Location	Existing Daytime L_{eq} Level (dBA)	Predicted Peak AM Traffic Sound Level	Incremental Increase (dBA)	FHWA Residential Criterion
R1: 48 Water Street, Holbrook	69	69	0	66
R2: 20 Water Street, Holbrook	51	61	9	66
R3: 364 Center Street, Randolph	68	63	0	66
R4: Holy Tabernacle Church, Randolph	59	63	4	66
R5: 15 Englewood Avenue, Randolph	62	58	0	66

6.3 Acoustic Modeling of Equipment Backup Alarms

The sound from truck and equipment safety alarms (backup alarms) is exempt from state and local regulation (see Section 3.0). The design of the Facility will require haul trucks to back into the Building, which will involve the use of backup alarms. These backup alarm sounds would occur during the daytime (6:00 a.m. to 6:00 p.m.). In addition, the track mobile rail car mover will be used to move rail cars from the Building to the rail yard intermittently throughout the Facility’s operational day (6:00 a.m. to 10:00 p.m.).

The sound levels at the nearest residences were predicted using the Cadna-A model. The backup alarm sound power level of 108.5 dBA (108.5 dB in the 1,000 Hz band) was calculated based on sound pressure level measurements.⁸ A usage factor of five percent was calculated based on a peak hour of 17 trucks in an hour would backup into the Building and that it would take 10 seconds for each haul truck to back into the Building. The same usage factor was used for the track mobile rail car mover to represent the intermittent operations of moving rail cars. The five percent was applied to the backup alarm sound power level for both activities to represent the percentage of time that backup alarms will

⁸ Based on a Tech Environmental measurement of a backup alarm.

operate in any one hour period. The predicted sound levels at the nearest residential receptors range from 46 to 51 dBA, as shown in Table 8, and are equal to or 1 dBA above existing daytime L₉₀ sound levels at all locations.

During the evening hours, the track mobile rail car mover would be the only piece of equipment operating outdoors that would have a backup alarm. The same usage factor of five percent described above was applied to the backup alarm sound power level. The predicted sound levels at the nearest residential receptors range from 45 to 47 dBA, as shown in Table 9, and are equal to or 1 dBA above existing evening L₉₀ sound levels at all locations.

Therefore, the backup alarm will sometimes be inaudible to slightly audible during the day and evening in certain residential areas. This is a typical circumstance for residences that abut industrial areas, similar to the project site.

TABLE 8
COMPARISON OF PREDICTED EQUIPMENT SAFETY ALARM
SOUND LEVELS TO EXISTING DAYTIME AVERAGE SOUND LEVELS
AT THE CLOSEST NOISE SENSITIVE AREAS

Receptor Location	Measured Existing Daytime Average Sound Levels (L₉₀) (dBA)	Predicted Future Sound Level from Backup Alarm (dBA)	Predicted Average Sound Level Difference (dBA)
R1: 48 Water Street, Holbrook	48	48	0
R2: 20 Water Street, Holbrook	45	46	1
R3: 364 Center Street, Randolph	51	51	0
R4: Holy Tabernacle Church, Randolph	49	50	1
R5: 15 Englewood Avenue, Randolph	50	50	0

TABLE 9

**COMPARISON OF PREDICTED EQUIPMENT SAFETY ALARM
SOUND LEVELS TO EXISTING EVENING AVERAGE SOUND LEVELS
AT THE CLOSEST NOISE SENSITIVE AREAS**

Receptor Location	Measured Existing Evening Average Sound Levels (L₉₀) (dBA)	Predicted Future Sound Level from Backup Alarm (dBA)	Predicted Average Sound Level Difference (dBA)
R1: 48 Water Street, Holbrook	46	46	0
R2: 20 Water Street, Holbrook	46	46	0
R3: 364 Center Street, Randolph	44	45	1
R4: Holy Tabernacle Church, Randolph	47	48	1
R5: 15 Englewood Avenue, Randolph	47	47	0

6.4 Rail Yard Operations

As stated in Section 3, the MassDEP does not regulate sound from locomotives and rail cars accessing the Site. Federal law pre-empts state and local governments from regulating sound from locomotives and rail cars by setting noise emissions limits on rail yards. EPA regulates railroad emissions standards under 40 CFR 201: *Noise Emission Standards for Transportation Equipment: Interstate Rail Carriers*. Nonetheless, a rail yard noise analysis was performed to provide context for the potential sound conditions for nearby noise-sensitive receptors.

The existing rail line has freight trains that operate throughout the day and night and up to 24 commuter trains per day of which 4-5 trains pass-by throughout the evening. There is a grade crossing located adjacent to the south side of the Site. Train horns are sounded at this location throughout the day and night. Thus, the ambient sound conditions in the area of the Facility already include rail activity noise.

The rail yard will be most active during the daytime and early evening when the transfer station is in full operation. There will be no train horns sounded in the Facility’s rail yard. Noise from rail car coupling activities produces instantaneous peak sounds, but there is no feasible technical solution on minimizing impact sound from coupling operations. The best way to reduce this impact sound is allowing rail cars to couple as smoothly as possible. Holbrook TLA will limit speeds in the rail yard to 5 mph to reduce the coupling sound impacts.

For the purposes of providing context of the potential sound impacts from the rail yard, the following sound sources were assumed to be operating in the rail yard: rail car coupling, a switch engine, an idling locomotive and a locomotive moving rail cars in the yard. Projected sound levels for each sound source were calculated based on the equations used in the Surface Transportation Board (STB)⁹ that are used to calculate day/night (DNL) sound levels. These sound levels were then converted to sound power levels and each source was added to the center of the rail yard in the acoustic model. Table 1 presents the projected DNL and sound power levels for each source.

TABLE 10
RAIL YARD SOUND LEVELS (dBA)

Sound Source	DNL (at 200 ft away) (dBA)	Sound Power Level (dBA)
Car Coupling	49	95
Switch Engine	52	98
Idling Locomotive	61	107
Locomotive with rail cars moving onsite	47	92

⁹ Surface Transportation Board, Norfolk Southern Railway Company, Pan Am Railways, Inc., et al.—Joint Control and Operating/Pooling Agreements—Pan Am Southern, LLC In NY, NH, VT, MA and CT, Appendix D, November 2008.

Table 11 presents the acoustic modeling results compared to existing L_{eq} sound levels measured at the nearest residences. The total late night noise level increases will be 4 dBA or less. A sound level increase of 4 dBA is considered a perceptible to noticeable change in sound. Again, this nighttime locomotive activity will be similar to the current active rail line adjacent to Site.

TABLE 11
PREDICTED FUTURE FACILITY & RAIL YARD SOUND LEVELS
AT THE CLOSEST RESIDENCES (dBA)

Receptor Locations	Measured Nighttime Average Sound Level (L_{eq}) (dBA)	Predicted Maximum Sound Level from the Facility (dBA)	Total L_{eq} Sound Level from the Facility (dBA)	Projected Sound Level Increase (dBA)
R1- 48 Water Street, Holbrook	55.7	43.1	55.9	0.2
R2- 20 Water Street, Holbrook	55.6	45.9	56.0	0.4
R3- 364 Center Street, Randolph	55.4	50.6	56.6	1.2
R5 - 15 Englewood Avenue, Randolph	41.2	43.6	45.6	4.4

7.0 CONCLUSIONS

The results of the acoustic modeling analysis show that the operation of the proposed Facility will generate sound level impacts that will fully comply with the MassDEP Noise Policy and will not create a nuisance in nearby residential areas in either Holbrook or Randolph. In order to ensure that sound levels from the Facility comply with the MassDEP Noise Policy, the Facility will be operated so that roll-up doors are kept closed to the extent practical except when it is necessary for a truck or rail car to enter or leave the building. Additionally a two-sided wall will be constructed around the waste compactor in the residential recycling area. Based on these analyses and our experience at other similar facilities, the Facility will not cause an adverse impact to health, safety or the environment with respect to noise. Further, even though certain aspects of the facility's operations are exempted from the MassDEP Noise Policy (e.g. back up alarms and rail yard activities and truck traffic), Tech placed all potential sources of sound within its model to create a conservative analysis regarding the creation of potential nuisance noise conditions at surrounding receptors. Even when taking into consideration exemptible/allowable sounds outside of the MassDEP's Noise Policy, it is our opinion that the Facility will fully comply with state standards based on out variables outlined in this report.

Acoustic Louvers

A Complete Range of Certified, High-Performance Acoustic Louvers to Solve Diverse Environmental Noise Pollution Problems



- Certified performance data per ASTM E90
- Easy to install and engineered for high performance
- Rugged galvanized construction (other materials available)
- Standard and specialty shaped louvers available
- Louver barriers/walls
- Airfoil and straight splitter blades available
- Variety of durable attractive finishes
- Over 60 years experience



IAC Acoustics

Making the World a Quieter Place

Founded on an unrivalled history of engineering with some of the most pioneering discoveries in the industry, the IAC Acoustics brand is synonymous with technological innovation.

From controlling noise at a power station to tuning the sound in a TV or radio studio, IAC Acoustics has had a positive impact on society and helped to shape what can be achieved to make speech more intelligible, make music more enjoyable, reduce the impact of industrial noise and protect people's sense of hearing.

The continual success of our products and services over the decades has brought the brand a reputation for quality and reliability among customers, whether they are multinational corporations or independent family businesses. This is supported by the expertise and passion of our workforce, the people behind the products, including designers, engineers and industry experts.

To face the ever increasing noise reduction demands of the future, we will strive to further enhance our ability to reduce excessive noise. We aim to focus on developing tomorrow's solution today, innovating faster and delivering solutions that meet the requirements of the next generation. In doing so, we will stay true to our key values and founding philosophy to make the world a quieter place.

Table of Contents

Page	
4	Acoustic Louvers Overview
6	Acoustic Louvers Range
8	Acoustic Louver Features
10	How to Specify Acoustic Louvers
12	Acoustic Louver Installation
14	Acoustic Louvers Specifications
16	- Model R Noishield™ Acoustic Louver
17	- Model 2R Noishield™ Acoustic Louver
18	- Model LP Noishield™ Acoustic Louver
19	- Model 2LP Noishield™ Acoustic Louver
20	- Model LF2-24 Noishield™ Acoustic Louver
22	- SL-4 Slimshield™ Acoustic Louver
23	- SL-6 Slimshield™ Acoustic Louver
24	- SL-12 Slimshield™ Acoustic Louver
25	- SL-24 Slimshield™ Acoustic Louver
26	Acoustic Louvered Doors
28	Acoustic Louvers in Harsh Environments

Acoustic Louvers Overview

IAC Acoustics is a leading global manufacturer of rugged, high performance acoustic louvers and has completed thousands of installations worldwide. Applications include:

Air Conditioning Systems & Equipment

- Return air and supply systems
- Cross-talk silencers
- Recording and broadcasting studios
- Air conditioning and refrigeration equipment
- Ventilation openings
- Cooling towers
- Data centers
- Fans
- Hospitals
- Hotels and motels
- Boiler rooms
- Conference rooms

Industrial, Transportation & Construction Equipment

- Diesel generator sets
- Marine or propulsion fans
- Machinery enclosures
- Gas turbines
- Oil coolers
- Electric motors
- Trucks and buses
- Locomotives
- Transformer barriers
- Tractors
- Pumps
- Bulldozers
- Air compressors
- Diesel powered vehicles and equipment
- Industrial cooling towers
- Noise barriers
- Air coolers

IAC Acoustics can provide louver solutions to combat environmental noise problems in mixed commercial / residential areas, carrying out all relevant noise surveys and acoustical analysis.

Form & Function Together

IAC Acoustics Noishield™ (curved) or Slimshield™ (linear) blade louver styles can be used to match the overall scale and aesthetics of a new or existing building.

Our acoustic louvered screens result in a high performance solution to unwanted levels of noise without the need for additional architectural cladding.

Acoustic Louvers Range

Noishield™ – Airfoil Blade

- Model R & Model LP: 12" (305mm) deep
- Model 2R & Model 2LP: 24" (610mm) deep
- LF2-24: 24" (610mm) deep

Slimshield™ – Linear Blade

- SL-4: 4" (101mm deep)
- SL-6: 6" (152mm) deep
- SL-12: 12" (305mm deep)
- SL-24 (double banked): 24" (610mm deep)

Noishield™ Louvers – Sound Transmission Loss (dB)

Model	Louver Depth	Octave Band Center Frequency, Hz							
		63	125	250	500	1k	2k	4k	8k
Sound Transmission Loss, dB									
Model R	12"	5	7	11	12	13	14	12	9
Model 2R	24"	6	12	15	21	24	27	25	20
Model LP	12"	4	5	8	9	12	9	7	6
Model 2LP	24"	5	8	12	16	22	18	15	14
Model LF2-24	24"	6	11	19	24	28	23	17	17

Slimshield™ Louvers – Sound Transmission Loss (dB)

Model	Louver Depth	Octave Band Center Frequency, Hz							
		63	125	250	500	1k	2k	4k	8k
Sound Transmission Loss, dB									
SL-4	4"	5	4	5	6	9	13	14	13
SL-6	6"	6	6	8	10	14	18	16	15
SL-12	12"	6	7	10	12	18	18	14	13
SL-24	24"	7	9	12	24	31	33	29	30

IAC Acoustics' acoustical louvers adhere to and are applicable to ASTM Standard E90.

Integrated or Standalone

Our acoustic louvers can be used as standalone screens around mechanical plants, or be integrated into walls and building façades.

Product Features

Our acoustic louvers are multi-purpose, permitting air to flow, while shielding the environment from unwanted noise.

Both IAC Acoustics Noishield™ and Slimshield™ louvers are available in an array of standard modular sizes, meaning that a wide range of performance requirements can be met. By using our range of acoustic louvers, it overcomes architectural consistency issues, especially where space is limited.

Where access is required, both Noishield™ and Slimshield™ acoustic louvers can be supplied as doorsets, either for inclusion in louvered screens, or as standalone units.



Noishield™ Louver

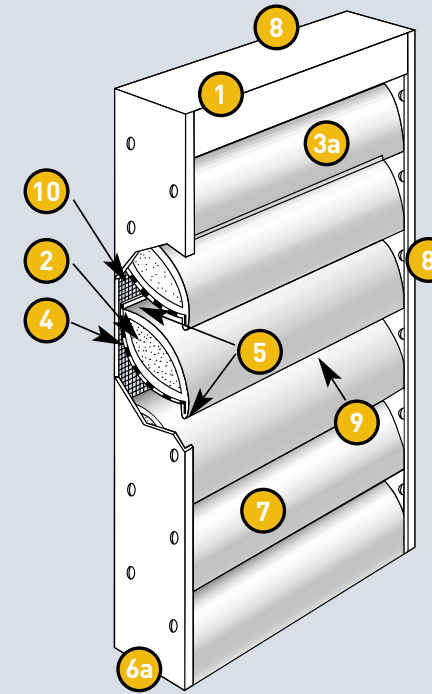

Slimshield™ Louver

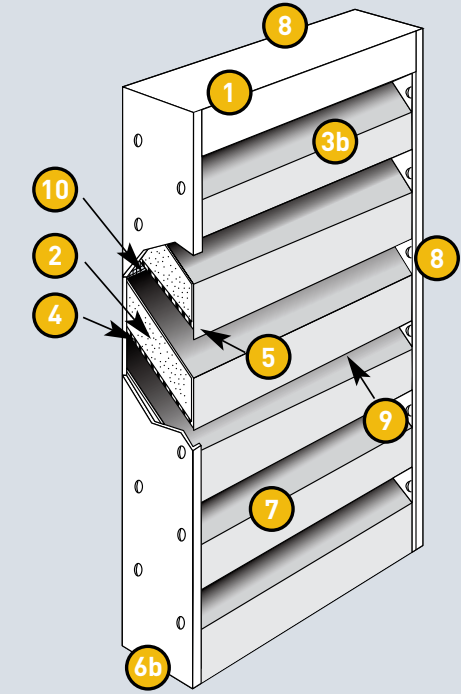

Noishield™ Special Features

- Suitable for use behind architectural louvers (4" / 101mm air space is required between faces)
- Bold, curved blade appearance
- A highly economical louver system

Finishes Available

- Galvanized mill steel
- Aluminum
- Stainless steel
- Power coated finish

Other non-standard finishes are available including:

- Galvanized G-90 mill finish
- Galvannealed A-60 in various finishes
- Anodized aluminum
- Stainless steel
- Kynar finish

Slimshield™ Special Features

- Linear appearance
- Superior high frequency performance



- ① Rugged all-steel galvanized construction. Stainless steel, aluminum and other materials are also available
- ② Inert, vermin-proof, weather-rated non combustible acoustic fill
- ③a **FOR NOISHIELD™** airfoil shaped splitter blade for maximum noise reduction with minimum pressure drop
- ③b **FOR SLIMSHIELD™** linear blade appearance for superior high frequency performance
- ④ Perforated splitter underside for maximum sound absorption
- ⑤ Weather stop inhibits rain / snow entry
- ⑥a **FOR NOISHIELD™** 12" (305mm) for the single banked system or 24" (610mm) deep for the double banked system
- ⑥b **FOR SLIMSHIELD™** 4, 6, 12" (101, 152, 305mm) deep single banked systems and 24" (610mm) deep for the double banked system
- ⑦ Available in a variety of durable, attractive finishes, including powder finish, Kynar, mill finish aluminum, anodized aluminum, galvanized and stainless steel
- ⑧ Modular sizes enable assembly of rectilinear louver 'screens' of almost any size
- ⑨ Louver blade orientation blocks horizontal line of site, enhancing both aesthetics and acoustic performance
- ⑩ Bird screens are available in galvanized or stainless steel, insect screens can also be supplied

How to Specify Acoustic Louvers

Specifying Noishield™ Louvers

Furnish and install Noishield™ louvers as manufactured by IAC Acoustics. For Model R, Model LP and Model LF2-24, outer casings are made of 16 gauge (1.613 mm) galvanized steel. Louver splitter blades (baffles) are airfoil configuration and made of 22 gauge (0.8534 mm) galvanized steel. They are packed with inert, vermin and moisture proof mineral fiber and provide the acoustical performance as indicated. For Model R, Model 2R, Model LP and Model 2LP, birdscreens are standard on one side only. Birdscreens will be installed on the perf side as standard. For Model LF2-24, birdscreens are not included. Please contact IAC Acoustics for birdscreen and installation options.

Specifying Slimshield™ Louvers

Furnish and install Slimshield™ louvers as manufactured by IAC Acoustics. For SL-4, outer casings are made of 18 gauge (1.27 mm) galvanized steel. For SL-6, SL-12 and SL-24, outer casings are made of 16 gauge (1.613 mm) galvanized steel. Louver splitter blades (baffles) for all models are made of 22 gauge (0.8534 mm) galvanized steel. They are packed with inert, vermin and moisture proof mineral fiber and provide the acoustical performance as indicated. For all Slimshield™ louvers, birdscreens are not included. Please contact IAC Acoustics for birdscreen options.

IAC Acoustics' acoustical louvers adhere to and are applicable to ASTM Standard E90.



Acoustic Louver Installation

Typical details are shown below. IAC Acoustics will supply all supporting steelwork if necessary. For large louver banks, IAC Acoustics can supply supporting steelwork, engineering services and drawings along with installation if desired.

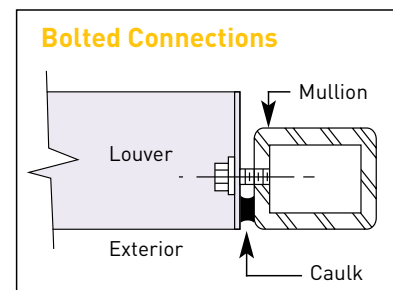
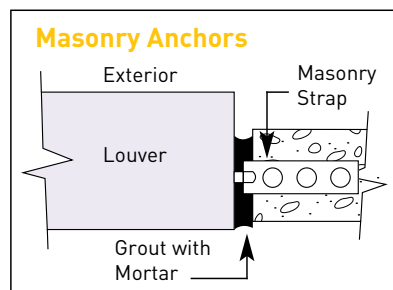
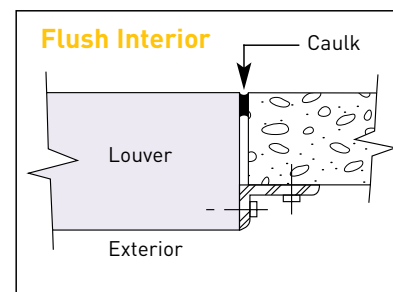
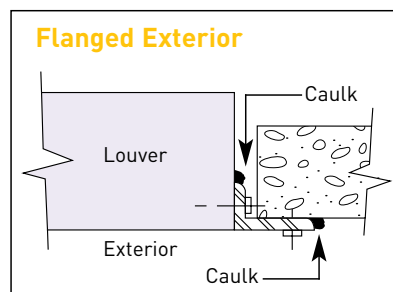
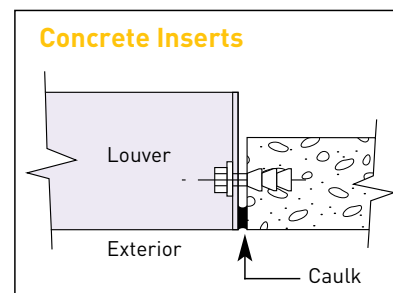
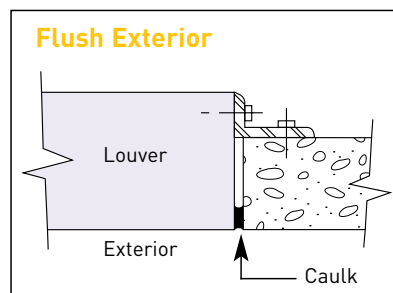

Integrated or Standalone

Our acoustic louvers can be used as standalone screens around mechanical plants, or be integrated into walls and building façades.

Acoustic Louver Specifications

Page

- 16 Model R Noishield™ Acoustic Louver
- 17 Model 2R Noishield™ Acoustic Louver
- 18 Model LP Noishield™ Acoustic Louver
- 19 Model 2LP Noishield™ Acoustic Louver
- 20 Model LF2-24 Noishield™ Acoustic Louver
- 22 SL-4 Slimshield™ Acoustic Louver
- 23 SL-6 Slimshield™ Acoustic Louver
- 24 SL-12 Slimshield™ Acoustic Louver
- 25 SL-24 Slimshield™ Acoustic Louver



Noishield™ Acoustic Louvers (Model R)

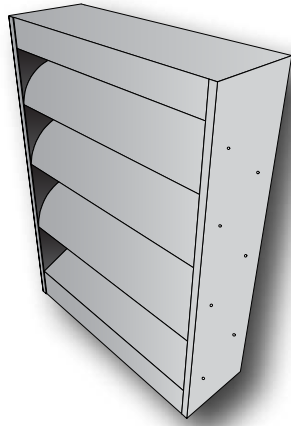

Weight

11 lbs/ft² (54kg/m²)

Typical Module Width

12" - 72" (305-1829mm)

Standard Module Height

24" - 144" with increments of 12"
(610mm - 3658mm with increments of 305mm)

Intermediate heights are available

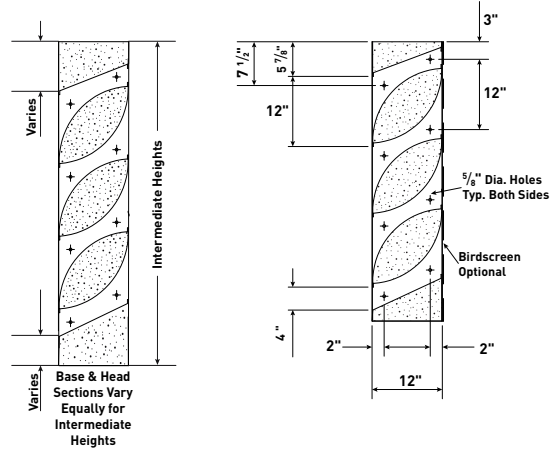

Noishield™ Acoustic Louvers (Model 2R)

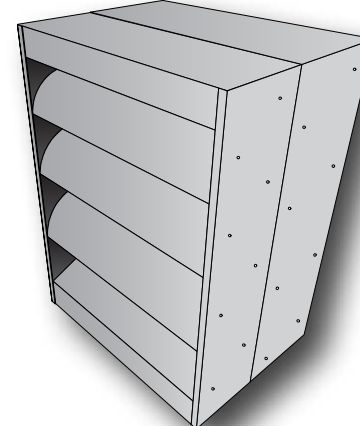

Weight

22 lbs/ft² (107kg/m²)

Typical Module Width

12" - 72" (305-1829mm)

Standard Module Height

24" - 144" with increments of 12"
(610mm - 3658mm with increments of 305mm)

Intermediate heights are available

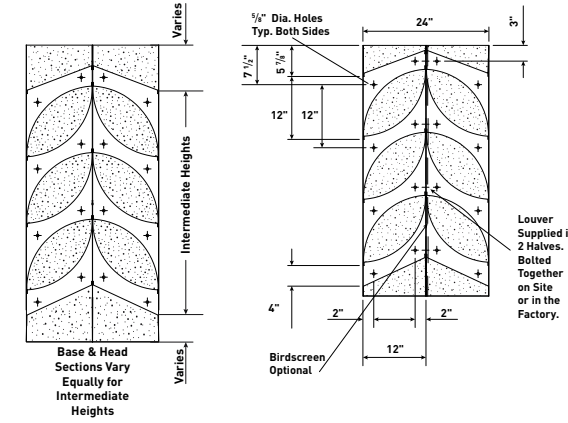

Acoustic Performance

Octave Band Center Frequency (Hz)	63	125	250	500	1K	2K	4K	8K
Transmission Loss (dB)	5	7	11	12	13	14	12	9

Transmission Loss tested in accordance with ASTM E90.
For Noise Reduction, add 6 dB to the above values.

Water Penetration

To minimize water penetration, limit face velocity to 225 ft/min (1.2 m/sec).

Acoustic Louvered Doors

- Single and double doors are available in the Model R louver range
- See page 28 for further details

Aerodynamic Performance

Static Pressure Drop (i.w.g.)	.05	.10	.15	.20	.25	.30	.40	.50	.60	.75	1.0	1.25
Face Velocity (fpm)	215	305	375	430	480	525	610	675	745	830	960	1070

For other velocities:
 $\Delta P_2 = \Delta P_1 \left(\frac{V_2}{V_1}\right)^2$
 Ex: 5,000 cfm through a 24" w x 60" h Model R Louver
 Face Velocity = $V = 5,000 \text{ cfm} / 10 \text{ ft}^2 = 500 \text{ ft/min}$
 $\Delta P_s = 0.25 \times (500/480)^2 = 0.27'' \text{ wc}$

Nominal Free Area for standard heights: 20%

Self-Noise (SN) Power Levels (Lw)

Octave Band	1	2	3	4	5	6	7	8
Hz	63	125	250	500	1K	2K	4K	8K
Louver Face Velocity (V), fpm								
-1000	72	78	74	68	66	64	62	53
-750	69	70	66	61	59	57	50	44
-500	53	53	50	47	45	41	33	24
500	56	54	52	48	43	40	32	22
750	69	72	69	66	58	54	51	43
1000	74	81	80	75	67	62	61	54

For areas other than 4 ft², add or subtract from above Lw values:

$$10 \text{ LOG} \left(\frac{\text{Louver Face Area, ft}^2}{4} \right)$$

Ex 1: 48" x 48" SN @ +500 ft/min @ 1 kHz = 43 + 10 LOG (16/4) = 43 + 6 = 49 dB
 Ex 2: 12" x 24" SN @ +500 ft/min @ 1 kHz = 43 + 10 LOG (2/4) = 43 - 3 = 40 dB

Self-Noise Test Arrangement

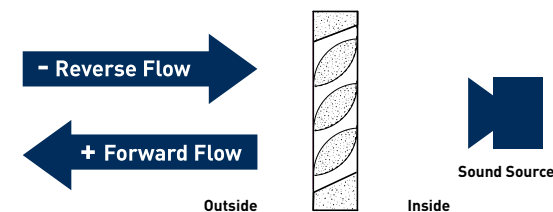

Acoustic Performance

Octave Band Center Frequency (Hz)	63	125	250	500	1K	2K	4K	8K
Transmission Loss (dB)	6	12	15	21	24	27	25	20

Transmission Loss tested in accordance with ASTM E90.
For Noise Reduction, add 6 dB to the above values.

Water Penetration

To minimize water penetration, limit face velocity to 225 ft/min (1.2 m/sec).

Aerodynamic Performance

Static Pressure Drop (i.w.g.)	.05	.10	.15	.20	.25	.30	.40	.50	.60	.75	1.0	1.25
Face Velocity (fpm)	154	235	264	305	337	364	371	468	509	573	661	739

For other velocities:
 $\Delta P_2 = \Delta P_1 \left(\frac{V_2}{V_1}\right)^2$
 Ex: 5,000 cfm through a 24" w x 60" h Model 2R Louver
 Face Velocity = $V = 5,000 \text{ cfm} / 10 \text{ ft}^2 = 500 \text{ ft/min}$
 $\Delta P_s = 0.50 \times (500/468)^2 = 0.57'' \text{ wc}$

Nominal Free Area for standard heights: 20%

Self-Noise (SN) Power Levels (Lw)

Octave Band	1	2	3	4	5	6	7	8
Hz	63	125	250	500	1K	2K	4K	8K
Louver Face Velocity (V), fpm								
-1000	76	81	77	71	66	63	60	57
-750	71	71	67	62	57	54	50	45
-500	58	58	54	49	43	39	33	24
500	64	64	59	57	49	47	43	35
750	75	76	72	70	62	57	56	50
1000	80	85	81	78	71	65	62	60

For areas other than 4 ft², add or subtract from above Lw values:

$$10 \text{ LOG} \left(\frac{\text{Louver Face Area, ft}^2}{4} \right)$$

Ex 1: 48" x 48" SN @ +500 ft/min @ 1 kHz = 49 + 10 LOG (16/4) = 49 + 6 = 55 dB
 Ex 2: 12" x 24" SN @ +500 ft/min @ 1 kHz = 48 + 10 LOG (2/4) = 49 - 3 = 46 dB

Self-Noise Test Arrangement

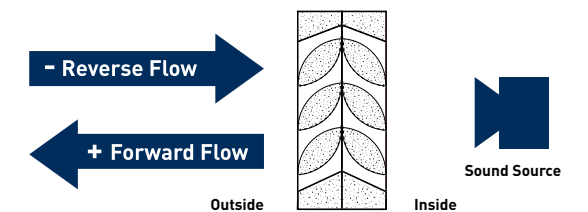

Noishield™ Acoustic Louvers (Model LP)

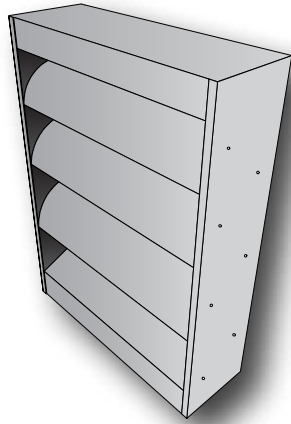

Weight

9.5 lbs/ft² (46.4 kg/m²)

Typical Module Width

12" - 72" (305-1829mm)

Standard Module Height

28" - 140" with increments of 14"
(711mm - 3658mm with increments of 356mm)

Intermediate heights are available

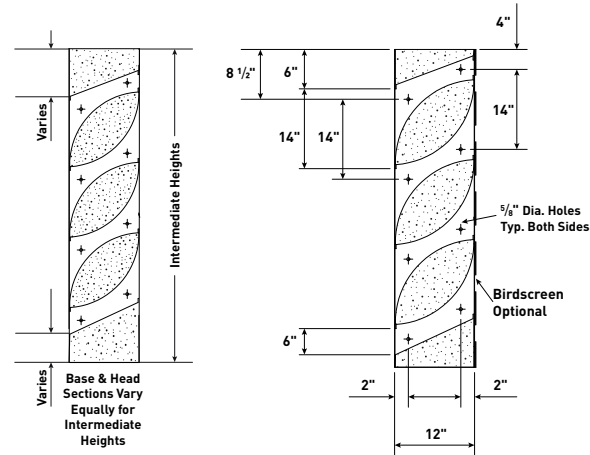

Noishield™ Acoustic Louvers (Model 2LP)

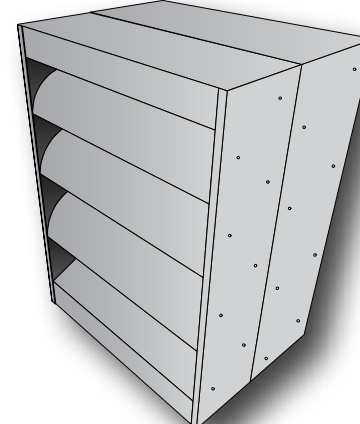

Weight

19 lbs/ft² (92.8kg/m²)

Typical Module Width

12" - 72" (305-1829mm)

Standard Module Height

28" - 140" with increments of 14"
(711mm - 3556mm with increments of 356mm)

Intermediate heights are available

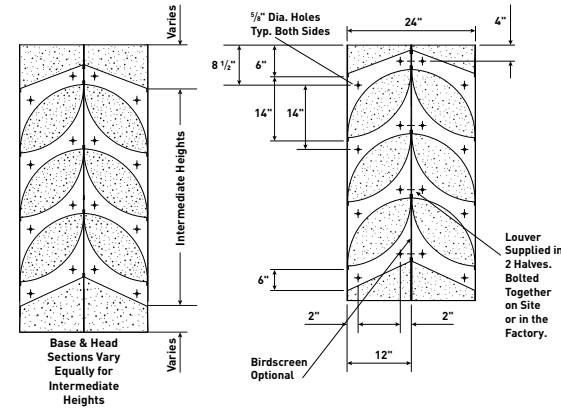

Acoustic Performance

Octave Band Center Frequency (Hz)	63	125	250	500	1K	2K	4K	8K
Transmission Loss (dB)	4	5	8	9	12	9	7	6

Transmission Loss tested in accordance with ASTM E90.
For Noise Reduction, add 6 dB to the above values.

Water Penetration

To minimize water penetration, limit face velocity to 315 ft/min (1.6 m/sec).

Acoustic Louvered Doors

- Single and double doors are available in the Model LP louver range
- See page 28 for further details

Aerodynamic Performance

Static Pressure Drop (i.w.g.)	.05	.10	.15	.20	.25	.30	.40	.50	.60	.75	1.0	1.25
Face Velocity (fpm)	270	380	465	540	600	660	760	850	925	1040	1200	1340

For other velocities:
 $\Delta P_2 = \Delta P_1 \left(\frac{V_2}{V_1}\right)^2$
 Ex: 5,000 cfm through a 24" w x 70" h Model LP Louver
 Face Velocity = V = 5,000 cfm / 11.67 ft² = 429 ft/min
 $\Delta P_s = 0.10 \times (429/380)^2 = 0.13$ wc

Nominal Free Area for standard heights: 30%

Self-Noise (SN) Power Levels (Lw)

Octave Band	1	2	3	4	5	6	7	8
Hz	63	125	250	500	1K	2K	4K	8K
Louver Face Velocity (V), fpm								
-1000	72	75	71	67	61	60	55	49
-750	66	68	64	60	54	52	46	39
-500	54	57	54	49	43	40	31	24
500	58	61	58	55	48	46	38	30
750	69	73	70	67	60	57	52	45
1000	77	81	79	77	70	64	60	55

For areas other than 4.67 ft²,
add or subtract from above Lw values:

$$10 \text{ LOG} \left(\frac{\text{Louver Face Area, ft}^2}{4.67} \right)$$

Ex 1: 24" x 84" SN @ +500 ft/min @ 1 kHz = 44 + 10 LOG (14/4.67) = 44 + 4.8 = 48.8 dB
 Ex 2: 12" x 42" SN @ +500 ft/min @ 1 kHz = 43 + 10 LOG (3.5/4.67) = 44 - 1.3 = 42.7 dB

Self-Noise Test Arrangement

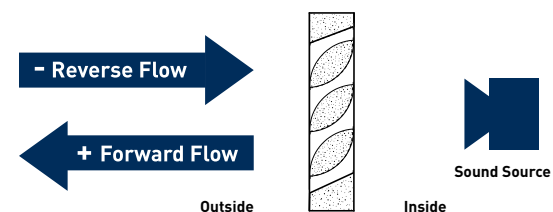

Acoustic Performance

Octave Band Center Frequency (Hz)	63	125	250	500	1K	2K	4K	8K
Transmission Loss (dB)	5	8	12	16	22	18	15	14

Transmission Loss tested in accordance with ASTM E90.
For Noise Reduction, add 6 dB to the above values.

Water Penetration

To minimize water penetration, limit face velocity to 315 ft/min (1.6 m/sec).

Aerodynamic Performance

Static Pressure Drop (i.w.g.)	.05	.10	.15	.20	.25	.30	.40	.50	.60	.75	1.0	1.25
Face Velocity (fpm)	235	310	377	434	493	533	613	685	758	852	984	1100

For other velocities:
 $\Delta P_2 = \Delta P_1 \left(\frac{V_2}{V_1}\right)^2$
 Ex: 5,000 cfm through a 24" w x 70" h Model 2LP Louver
 Face Velocity = V = 5,000 cfm / 11.67 ft² = 429 ft/min
 $\Delta P_s = 0.15 \times (429/377)^2 = 0.19$ wc

Nominal Free Area for standard heights: 30%

Self-Noise (SN) Power Levels (Lw)

Octave Band	1	2	3	4	5	6	7	8
Hz	63	125	250	500	1K	2K	4K	8K
Louver Face Velocity (V), fpm								
-1000	76	81	77	71	66	63	60	57
-750	71	71	67	62	57	54	50	45
-500	58	58	54	49	43	39	33	24
500	64	64	59	57	49	47	43	35
750	75	76	72	70	62	57	56	50
1000	80	85	81	78	71	65	62	60

For areas other than 4.67 ft²,
add or subtract from above Lw values:

$$10 \text{ LOG} \left(\frac{\text{Louver Face Area, ft}^2}{4.67} \right)$$

Ex 1: 24" x 84" SN @ +500 ft/min @ 1 kHz = 48 + 10 LOG (14/4.67) = 48 + 4.8 = 52.8 dB
 Ex 2: 12" x 42" SN @ +500 ft/min @ 1 kHz = 48 + 10 LOG (3.5/4.67) = 48 - 1.3 = 46.7 dB

Self-Noise Test Arrangement

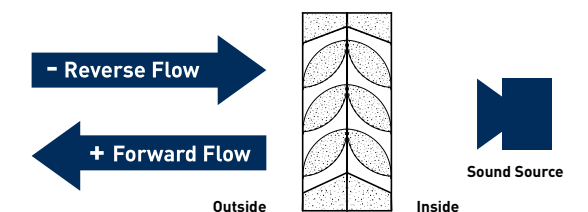

Noishield™ Acoustic Louvers (Model LF2-24)

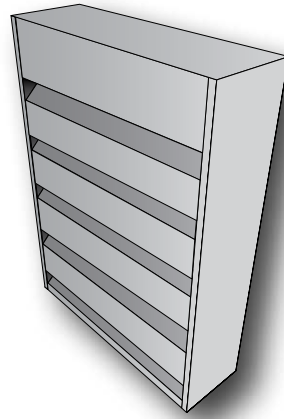

Weight

22 lbs/ft² (107.4 kg/m²)

Typical Module Width

12" - 48" (305 - 1219 mm)

Standard Module Height

34" minimum, with increments of 17"
(863 mm minimum, with increments of 432 mm)

Intermediate heights are available

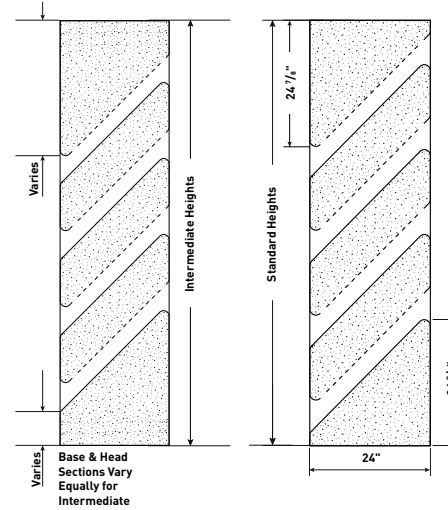

Acoustic Performance

Octave Band Center Frequency (Hz)	63	125	250	500	1K	2K	4K	8K
Transmission Loss (dB)	6	11	19	24	28	23	17	17

Transmission Loss tested in accordance with ASTM E90.
For Noise Reduction, add 6 dB to the above values.

Aerodynamic Performance

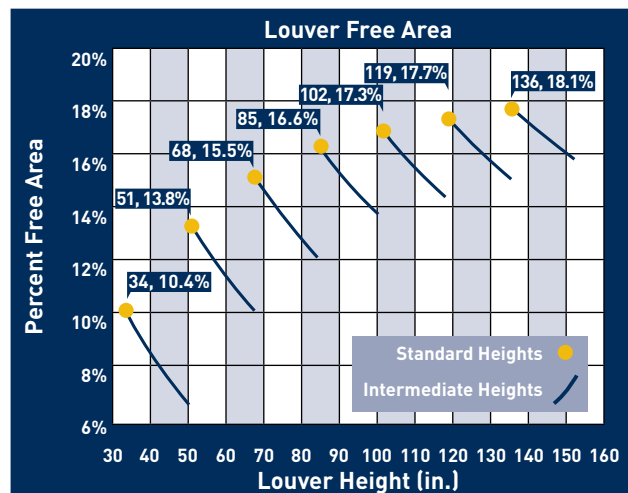

For other velocities:

$$\Delta P_2 = \Delta P_1 \left(\frac{V_2}{V_1} \right)^2$$

Ex: 20,000 cfm face velocity through a 48" w x 119" h Model LF2-24 Louver
Face Velocity = $V = 20,000 \text{ cfm} / 39.7 \text{ ft}^2 = 504 \text{ ft/min}$
 $\Delta P_s = 0.24 \times (504/400)^2 = 0.38'' \text{ wc}$

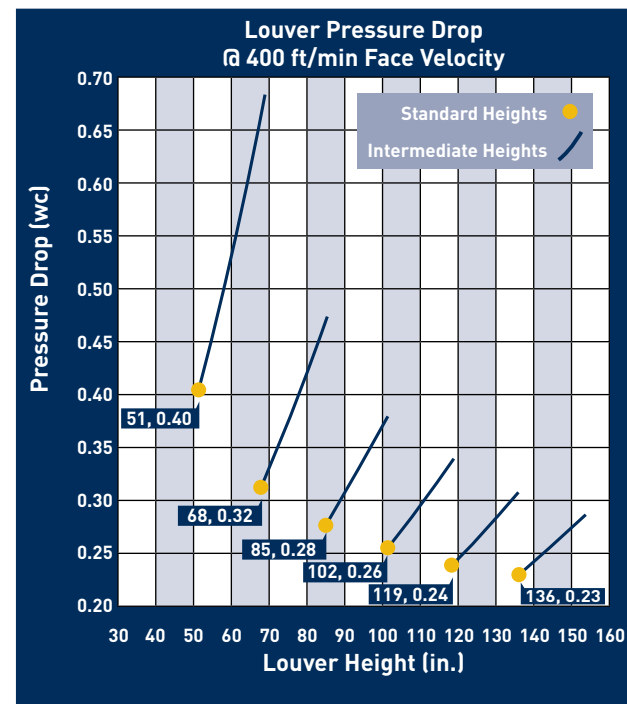

Slimshield™ Acoustic Louvers (Model SL-4)

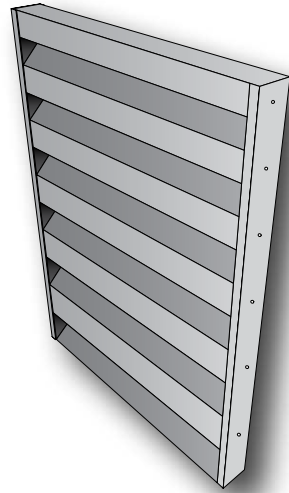

Weight

4 lbs/ft² (19.5 kg/m²)

Typical Module Width

12" - 60" (305-1524 mm)

Standard Module Height

18" minimum, with increments of 8" (450 mm minimum, with increments of 203 mm)

Intermediate heights are available

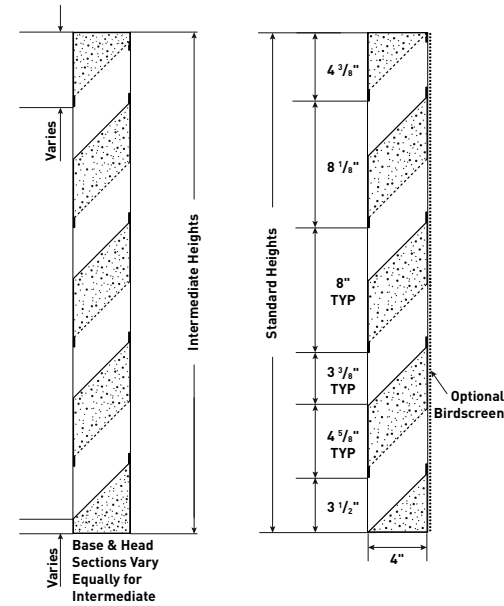

Slimshield™ Acoustic Louvers (Model SL-6)

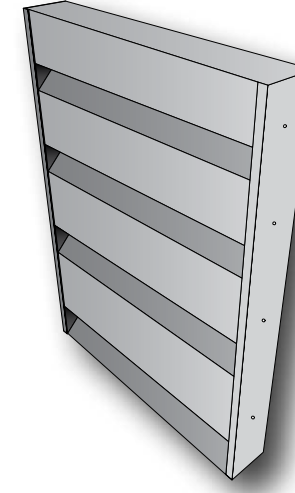

Weight

6 lbs/ft² (30kg/m²)

Typical Module Width

12" - 60" (305-1524mm)

Standard Module Height

18" - 140" with increments of 12" (450 mm minimum, with increments of 305 mm)

Intermediate heights are available

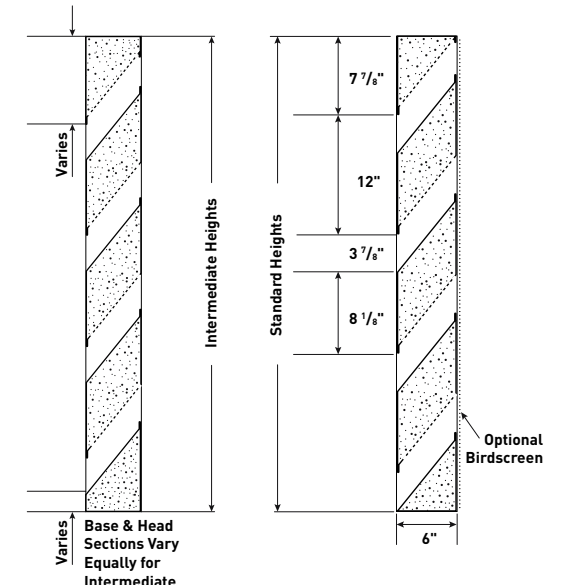

Acoustic Performance

Octave Band Center Frequency (Hz)	63	125	250	500	1K	2K	4K	8K
Transmission Loss (dB)	5	4	5	6	9	13	14	13

Transmission Loss tested in accordance with ASTM E90.
For Noise Reduction, add 6 dB to the above values.

Aerodynamic Performance

Static Pressure Drop (i.w.g.)	.05	.10	.15	.20	.25	.30	.40	.50	.60	.75	1.0	1.25
Face Velocity (fpm)	202	285	350	404	452	495	571	639	700	785	904	1011

For other velocities:
 $\Delta P_2 = \Delta P_1 \left(\frac{V_2}{V_1}\right)^2$
 Ex: 5,000 cfm through a 24" w x 64" h Model SL-4 Louver
 Face Velocity = $V = 5,000 \text{ cfm} / 10.67 \text{ ft}^2 = 469 \text{ ft/min}$
 $\Delta P_s = 0.30 \times (469/495)^2 = 0.27'' \text{ wc}$

Nominal Free Area for standard heights: 30%

Water Penetration

To minimize water penetration, limit face velocity to 217 ft/min (1.1 m/sec).

Acoustic Louvered Doors

- Single and double doors are available in the SL-4 louver range
- See page 28 for further details

Acoustic Performance

Octave Band Center Frequency (Hz)	63	125	250	500	1K	2K	4K	8K
Transmission Loss (dB)	6	6	8	10	14	18	16	15

Transmission Loss tested in accordance with ASTM E90.
For Noise Reduction, add 6 dB to the above values.

Aerodynamic Performance

Static Pressure Drop (i.w.g.)	.05	.10	.15	.20	.25	.30	.40	.50	.60	.75	1.0	1.25
Face Velocity (fpm)	115	160	197	228	255	280	322	360	395	440	510	570

For other velocities:
 $\Delta P_2 = \Delta P_1 \left(\frac{V_2}{V_1}\right)^2$
 Ex: 5,000 cfm through a 48" w x 60" h Model SL-6 Louver
 Face Velocity = $V = 5,000 \text{ cfm} / 20 \text{ ft}^2 = 250 \text{ ft/min}$
 $\Delta P_s = 0.25 \times (250/255)^2 = 0.24'' \text{ wc}$

Nominal Free Area for standard heights: 20%

Water Penetration

To minimize water penetration, limit face velocity to 175 ft/min (0.89 m/sec).

Acoustic Louvered Doors

- Single and double doors are available in the SL-6 louver range
- See page 28 for further details

Slimshield™ Acoustic Louvers (Model SL-12)

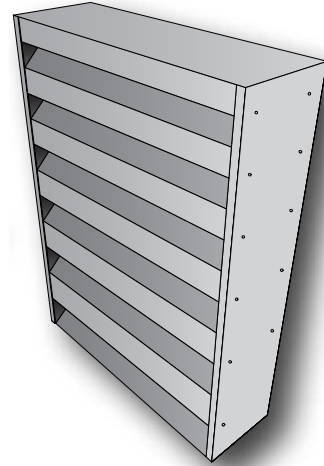

Weight

10.3 lbs /ft² (50 kg/m²)

Typical Module Width

12" - 72" (305-1829 mm)

Standard Module Height

24" minimum, with increments of 12" (600mm minimum, with increments of 305 mm)

Intermediate heights are available

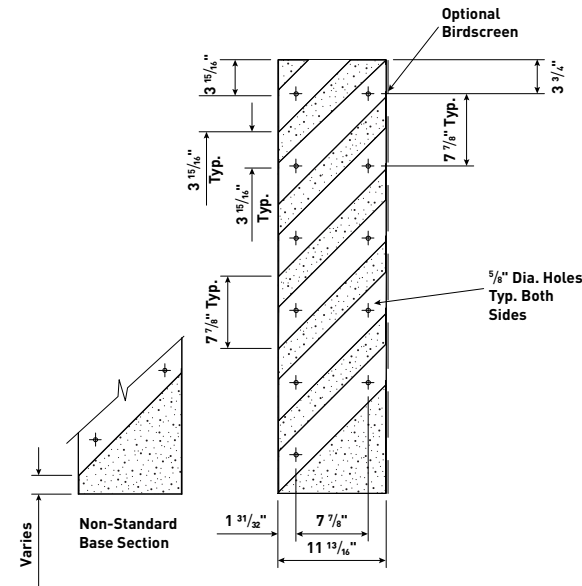

Slimshield™ Acoustic Louvers (Model SL-24)

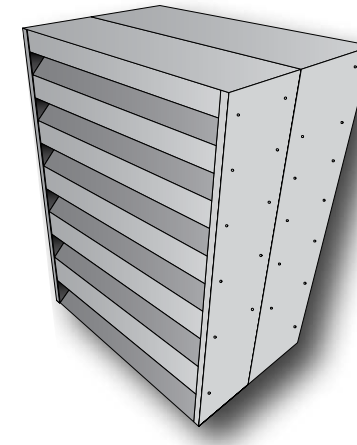

Weight

6 lbs /ft² (30kg/m²)

Typical Module Width

12" - 60" (305-1524mm)

Standard Module Height

24" - 140" with increments of 12" (600 mm minimum, with increments of 305 mm)

Intermediate heights are available

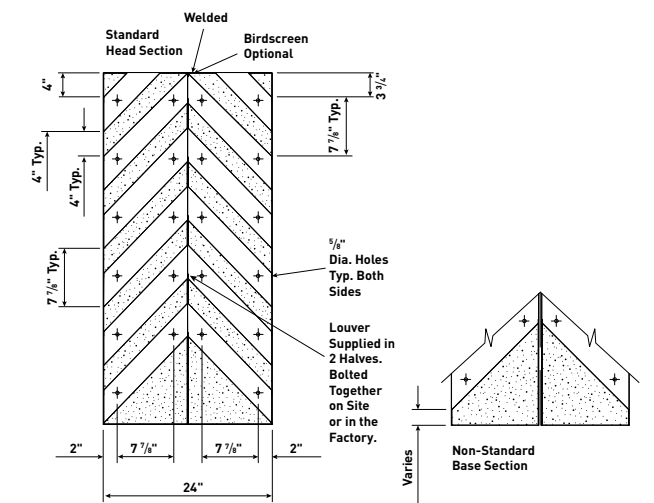

Acoustic Performance

Octave Band Center Frequency (Hz)	63	125	250	500	1K	2K	4K	8K
Transmission Loss (dB)	6	7	10	12	18	18	14	13

Transmission Loss tested in accordance with ASTM E90.
For Noise Reduction, add 6 dB to the above values.

Aerodynamic Performance

Static Pressure Drop (i.w.g.)	.05	.10	.15	.20	.25	.30	.40	.50	.60	.75	1.0	1.25
Face Velocity (fpm)	206	292	357	413	461	505	584	653	715	799	923	1032

For other velocities:

$$\Delta P_2 = \Delta P_1 \left(\frac{V_2}{V_1} \right)^2$$
 Ex: 5,000 cfm through a 24" w x 63" h Model SL-12 Louver
 Face Velocity = $V = 5,000 \text{ cfm} / 10.5 \text{ ft}^2 = 476 \text{ ft/min}$
 $\Delta P_s = 0.30 \times (476/505)^2 = 0.27'' \text{ wc}$

Nominal Free Area for standard heights: 30%

Water Penetration

To minimize water penetration, limit face velocity to 309 ft/min (1.57 m/sec).

Acoustic Louvered Doors

- Single and double doors are available in the SL-12 louver range
- See page 28 for further details

Acoustic Performance

Octave Band Center Frequency (Hz)	63	125	250	500	1K	2K	4K	8K
Transmission Loss (dB)	7	9	12	24	31	33	29	30

Transmission Loss tested in accordance with ASTM E90.
For Noise Reduction, add 6 dB to the above values.

Aerodynamic Performance

Static Pressure Drop (i.w.g.)	.05	.10	.15	.20	.25	.30	.40	.50	.60	.75	1.0	1.25
Face Velocity (fpm)	149	207	247	289	323	360	419	468	511	569	657	734

For other velocities:

$$\Delta P_2 = \Delta P_1 \left(\frac{V_2}{V_1} \right)^2$$
 Ex: 5,000 cfm through a 24" w x 63" h Model SL-24 Louver
 Face Velocity = $V = 5,000 \text{ cfm} / 10.5 \text{ ft}^2 = 476 \text{ ft/min}$
 $\Delta P_s = 0.50 \times (476/468)^2 = 0.52'' \text{ wc}$

Nominal Free Area for standard heights: 20%

Water Penetration

To minimize water penetration, limit face velocity to 309 ft/min (1.57 m/sec).

Acoustic Louvered Doors

- Single and double doors are available from the IAC Acoustics louver range
- The structural minimum is 33 1/2 in. (850mm) and is available up to 49" x 116" (1250 x 2950 mm) high as standard for a single door, and 98" x 116" (2500 x 2950 mm) high for a double door. Other widths and heights are available on request
- All doors can be supplied with various hardware, including hinges, latches, screws, nuts, bolts, washers, handles and supporting frames
- Acoustic louvered doors can be fitted with bird or insect screens on request
- Doors can be powder coated to match adjoining louvers
- Materials for the door and door frame include galvanized steel, stainless steel and aluminum
- Other door options may be available in the entire IAC Acoustics louver range. Please contact IAC Acoustics for more details.



A Quality Solution

All IAC Acoustics products are designed to stand the test of time and manufactured to suit the application. From offshore environments to extremes in weather and ambient temperature, we can produce a highly engineered solution to your noise control issue.



Harsh Environments

In addition to providing acoustic louvers located in everyday environments, IAC Acoustics also has the ability to modify products to suit more demanding applications.

A True World Leader

In addition to providing acoustic louvers, IAC Acoustics is also able to provide the following solutions to noise control:

- Acoustic barriers
- Acoustic doors
- Acoustic enclosures
- Acoustic studios
- Acoustic wall treatments
- Acoustic windows
- Aero-engine test facilities
- Anechoic chambers
- Anti-vibration mounts
- Audiology booths
- Engine exhaust silencers
- Gas turbine acoustic packages
- Ground run-up enclosures
- HVAC attenuators
- Jet blast deflectors
- Medical rooms
- Vent silencers

Our wealth of engineering experience means that custom solutions can also be tailored for specific client applications. Please contact your local IAC Acoustics office should you require a unique solution.

An Engineering Benchmark

IAC Acoustics products are respected worldwide for their quality and certified performance. Rest assured that IAC Acoustics can deliver a solution to your unwanted noise problem.



USA - North Aurora, IL

T: +1 (630) 270 1790

F: +1 (630) 966 9710

E: iacacoustics@soundseal.com



www.iacacoustics.com



FOR THE SCOPE OF
ACCREDITATION UNDER NVLAP
LAB CODE 100402-0.

REPORT

3933 US ROUTE 11 CORTLAND, NEW YORK 13045

Order No. 100096189

Date: May 21, 2010

REPORT NO. 100096189CRT-001a

SOUND TRANSMISSION LOSS TEST AND CLASSIFICATION OF FOUR ALPINE OVERHEAD DOORS

RENDERED TO

**ALPINE OVERHEAD DOOR INC,
8 HULSE ROAD
EAST SETAUKET, NY 11733**

INTRODUCTION

This report gives the results of Sound Transmission Loss tests and the determination of the Sound Transmission Class on four overhead doors. The samples were selected and supplied by the client and was received at the laboratories on May 11, 2010. The samples appeared to be in new, unused condition upon arrival.

AUTHORIZATION

Signed Intertek Quotation No. 500222012.

TEST METHOD

The specimen was tested in accordance with the American Society for Testing and Materials designation ASTM E90-2009, "Standard Test Method for Laboratory Measurement of Airborne Sound Transmission Loss of Building Partitions", and classified in accordance with the American Society for Testing and Materials designation ASTM E413-2004, "Classification for Rating Sound Insulation" and ASTM Standard E1332-90 (Re-Approved 2003) entitled, "Standard Classification for Determination of Outdoor-Indoor Transmission Class".

GENERAL

The sound-insulating property of a partition element is expressed in terms of the sound transmission loss. The procedure for determining this quantity is to mount (and perimeter seal) the test specimen as a partition between two reverberation rooms. Sound is introduced in one of the rooms (the source room) and measurements are made of the noise reduction between source room (10,000 cu. ft.) and receiving room (16,640 cu. ft.). The rooms are so arranged and constructed that the only significant sound transmission between them is through the test specimen.

The test opening is constructed such that it is approximately one inch larger in size than the test specimen. The specimen is placed in the test opening and a half-inch bead of "DUX-SEAL", a dense, non-hardening, clay-like material, to isolate it from the supporting base. The space between the test specimen and the wall opening is sealed on both sides employing the same sealing material.

The purpose of the Sound Transmission Class (STC) is to provide a single figure rating that can be used for comparing the sound-insulating properties of partition elements used for general building design purposes. The higher the rating (STC) the greater the sound insulating properties of the partition.

The purpose of the Outdoor-Indoor Transmission (OITC) is to provide a single number rating that can be used for comparing building façade designs, including walls, doors, windows and combinations thereof. This rating is designed to correlate with subjective impressions of the ability of building elements to reduce the overall loudness of ground and air transportation noise. It is intended to be used as a rank ordering device.

DESCRIPTION OF TEST SPECIMEN

Each test specimen consisted of an inoperable overhead door installed in a wood frame. The frame was sealed so only the door was contributing to the STC test.

Test Number 1 – Insulsound HP IPB – 123.5 lbs

Test Number 2 – Same as test 1 plus a 0.16 inch thick layer of foam on plastic side – 124.5 lbs

Test Number 3 – Insulsound IPB – 128 lbs

Test Number 4 – IMB – V8 – 140.5 lbs

RESULTS OF TEST

1/3 Octave Band Center Frequency Hz	Sound Transmission Loss in dB			
	<u>Test Number 1</u>	<u>Test Number 2</u>	<u>Test Number 3</u>	<u>Test Number 4</u>
80	18	18	18	13
100	21	20	20	14
125	23	23	22	16
160	25	25	22	17
200	23	23	20	15
250	26	26	23	18
315	28	28	24	19
400	27	27	24	19
500	25	26	24	19
630	24	24	25	20
800	23	23	28	22
1000	24	24	31	26
1250	25	25	34	25
1600	27	27	38	30
2000	30	30	44	29
2500	32	34	48	29
3150	35	38	52	32
4000	39	41	50	29
5000	43	45	48	24
STC – Sound Transmission Class	27	27	30	25
OITC – Outdoor Indoor Transmission Class	25	25	26	20

PRECISION

For any pair of rooms and microphone system, the 95% confidence interval Δ TL, for transmission loss must be less than the following.

Range of One-Third Octave Bands	Transmission Loss Uncertainty, dB	
	<u>Required</u>	<u>Actual</u>
125 and 160	3	<1.5
200 and 250	2	<1.5
315 - 4000	1	<1

TEST NUMBER 1

Sound Transmission Loss

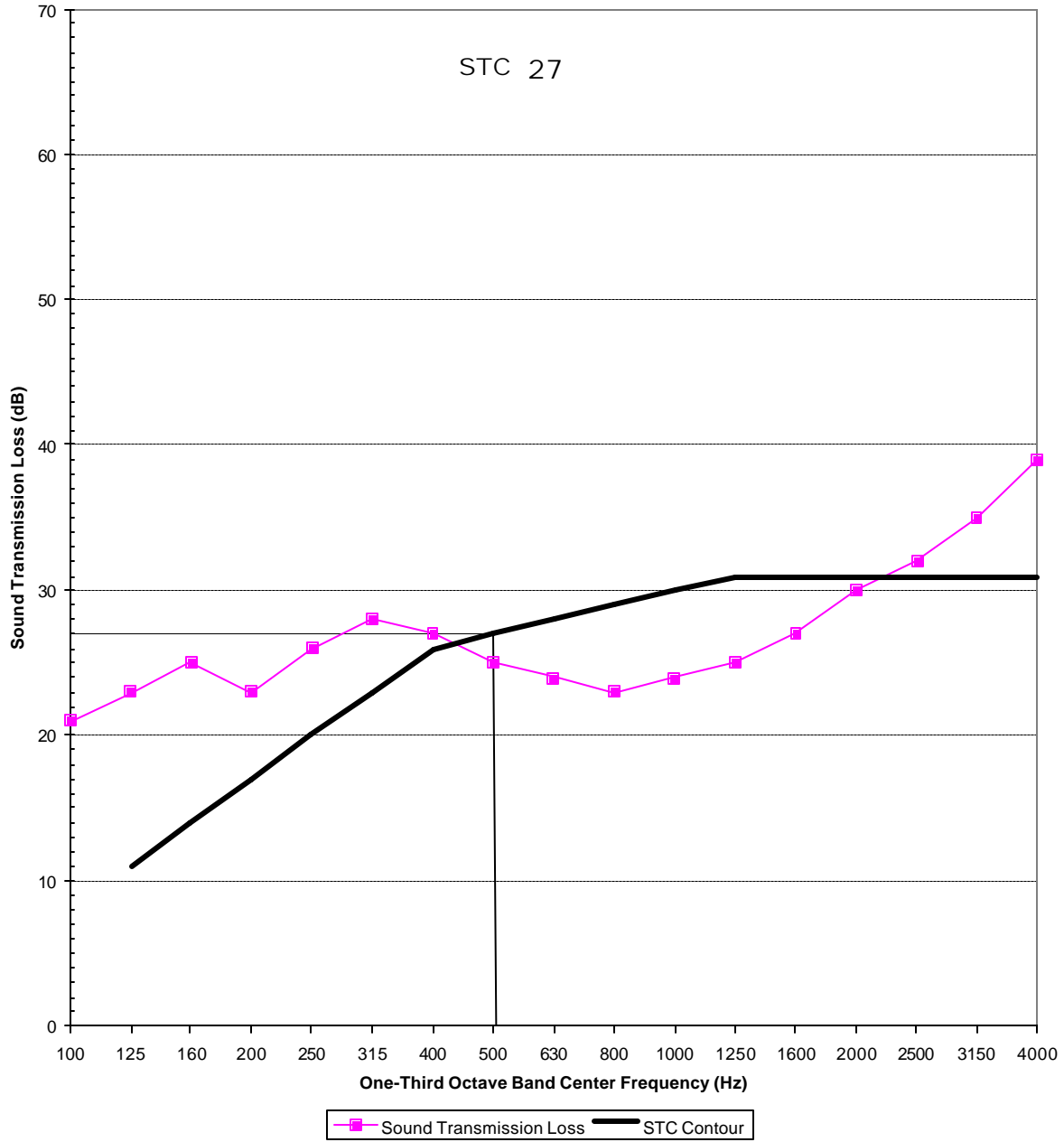

ALPINE OVERHEAD DOOR, INC.

TEST NUMBER 2

Sound Transmission Loss

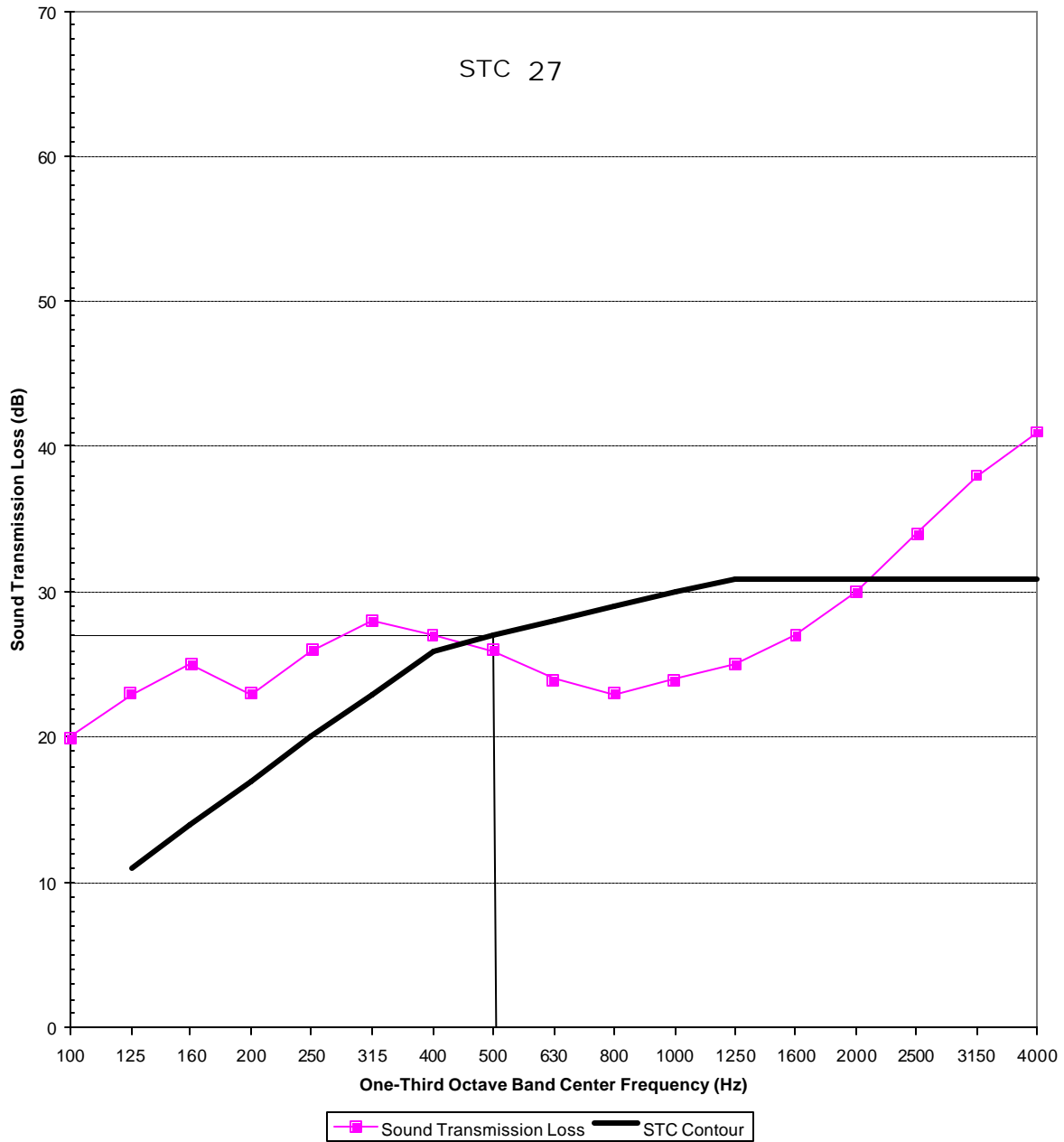

ALPINE OVERHEAD DOOR, INC.

TEST NUMBER 3

Sound Transmission Loss

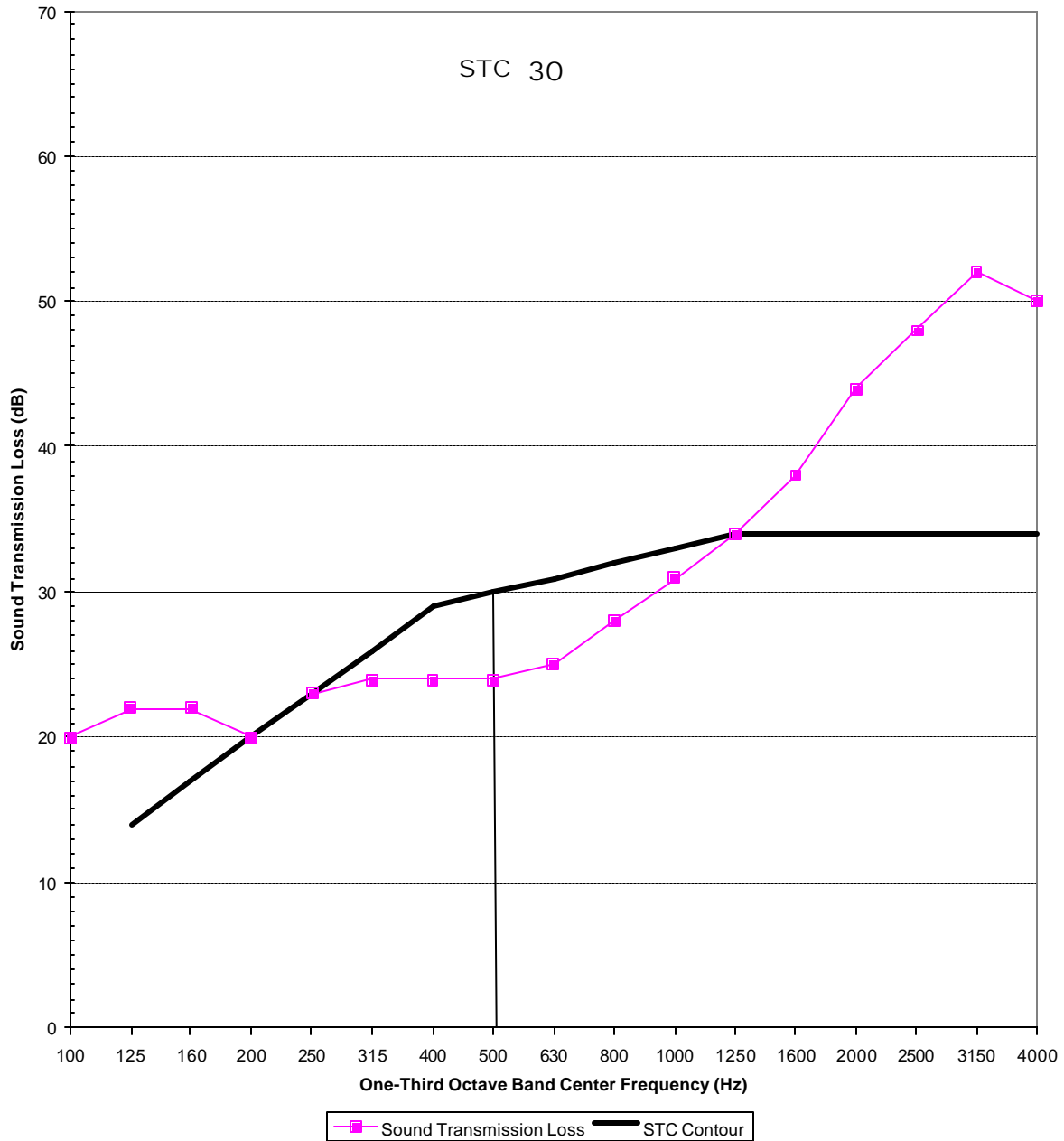

ALPINE OVERHEAD DOOR, INC.

TEST NUMBER 4

Sound Transmission Loss

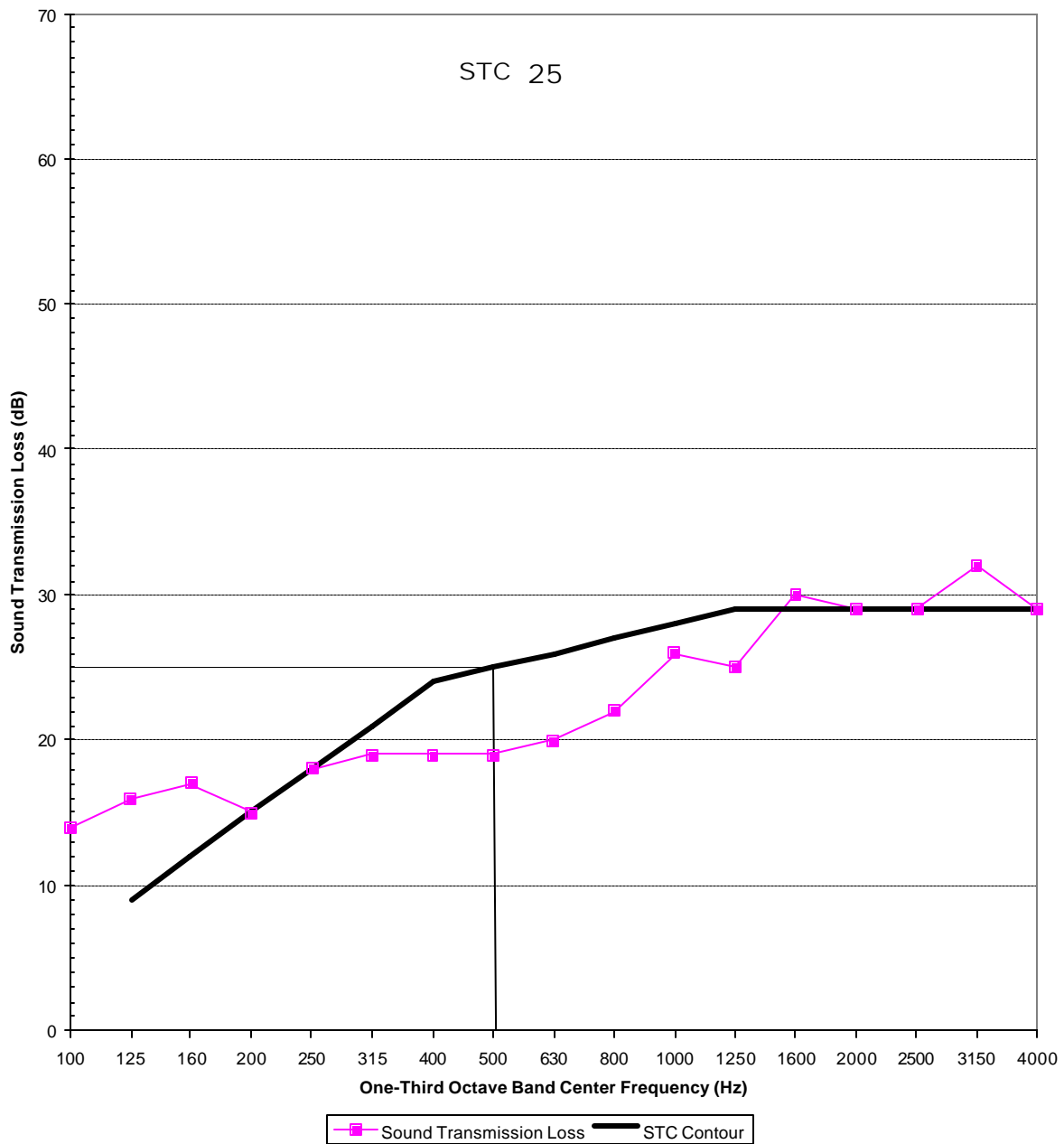

ALPINE OVERHEAD DOOR, INC.



REMARKS

1. Ambient Temperature: 72°F
2. Relative Humidity: 36%

CONCLUSION

The test method employed for this test has no pass-fail criteria, therefore, the evaluation of the test results is left to the discretion of the client.

This report must not be used by the client to claim product certification, approval, or endorsement by NVLAP, NIST, or any agency of the federal government.

Date of Tests: May 21, 2010

Report Approved by:

Brian Cyr
Engineer
Acoustical Testing

Report Reviewed By:

James R. Kline
Engineer/Quality Supervisor
Acoustical Testing

Attachments: None

CERTIFIED PERFORMANCE DATA

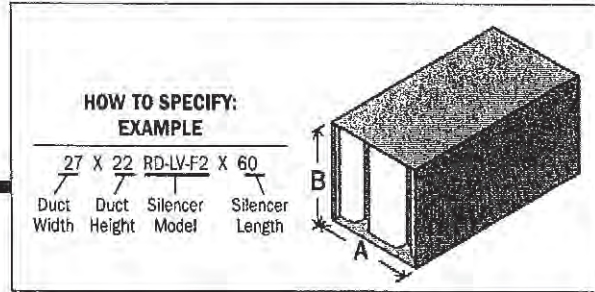

Insertion Loss (IL)

LENGTH (inches)	FACE VELOCITY (feet per minute)	OCTAVE BAND - Hz/DYNAMIC INSERTION LOSS (dB)							
		63	125	250	500	1000	2000	4000	8000
36	- 750	7	10	17	20	22	17	14	12
	0	5	10	17	19	22	18	15	12
	+ 750	5	9	16	18	22	19	15	12
60	- 750	10	15	26	32	36	26	18	14
	0	9	14	25	31	36	27	19	15
	+ 750	8	13	24	30	36	28	20	15
84	- 750	13	19	35	42	50	36	21	17
	0	12	18	34	41	50	36	23	18
	+ 750	11	17	32	40	50	38	24	18
108	- 750	16	23	44	46	55	43	25	19
	0	15	22	42	46	55	43	27	20
	+ 750	13	21	41	46	55	44	28	20

+ : "forward flow" where noise & airflow move in same direction (e.g. supply side)

- : "reverse flow" where noise & airflow move in opposite directions (e.g. return side)

See pages 4.1 - 4.25 for selection information. DIL above 50dB may be limited due to noise flanking around the silencer or along the duct walls. If more than 50dB DIL is required, contact your local Vibro-Acoustics Representative or call 1-800-565-8401.

Pressure Drop (PD)

LENGTH (inches)	FACE VELOCITY (feet per minute) / Pressure Drop (in.w.g.)						
	250	500	750	1000	1250	1500	1750
36	0.02	0.07	0.15	0.26	[Hatched Area]		
60	0.02	0.09	0.20	0.35			
84	0.03	0.11	0.24				
108	0.03	0.12	0.28				

[White Box] Acceptable (0 - 0.35")

[Hatched Area] : Caution (>0.35") Pressure Drop may be too high for certain applications

CROSS-SECTION SIZES*

"A" dimension (inches):

14
27-28
54-57
81-86
108-115
135-144
162-173
189-202
216-231

"B" dimension: ANY SIZE

Approx. weight 6.4 lbs/cu.ft.

Pressure drops are reported in accordance with ASTM E477 methods and are based upon IDEAL flow conditions (5 diameters of straight duct on silencer inlet and 10 on outlet). Less than ideal conditions will result in an increase in pressure drop due to System Effects. See Silencer System Effects Data on page 4.19.

Generated Noise (GN) @ 5 sq.ft. face area

LENGTH (inches)	FACE VELOCITY (feet per minute)	OCTAVE BAND - Hz/GENERATED NOISE (dB re 10 ⁻¹² watts)							
		63	125	250	500	1000	2000	4000	8000
ALL	- 750	51	45	42	46	48	47	34	27
	- 500	51	42	41	41	40	33	22	25
	+ 500	53	38	32	30	31	28	21	25
	+ 750	52	43	37	35	38	39	29	25

* To ensure a silencer selection that matches the ductwork dimensions, see page 4.25 or 5.3.

GN correction chart at right must be used to correct GN to other face areas.

FACE AREA (sq.ft.)	2.5	5	10	20	40	80
dB	-3	0	+3	+6	+9	+12

Questions? 1-800-565-8401

5.18

We reserve the right to improve our designs and data at any time without notice.

Copyright © 2010 Vibro-Acoustics

RD-LV-F2

Manufacturer's data should always be used for fan sound power levels. These data are typically sound power levels of inlet, discharge and casing. The inlet and discharge levels are those that are inside the duct. To use these levels to calculate the sound power radiated externally through the fan casing and adjacent ductwork, the corrections listed in Table 11.3 may be used, or alternatively see Section 9.12. These corrections assume standard rectangular ductwork lined on the inside, beginning a short distance from the fan. To calculate the sound power emerging from the end of the duct, the attenuation due to duct linings, duct end reflections, duct bends and plenum chambers must be taken into account as discussed in Chapter 9.

Table 11.3 Octave band adjustments for sound power radiated by fan housings and adjacent ductwork

Octave band centre frequency (Hz)	Value to be subtracted from calculated in-duct sound power level, L_w (dB)
63	0
125	0
250	5
500	10
1000	15
2000	20
4000	22
8000	25

Data from Army, Air Force and Navy, USA (1983a).

In designing air handling systems, fan noise can be minimised by minimising air flow resistance and system pressure losses. In some cases the BPF tone or its harmonics may be amplified over the manufacturer's specifications due to a number of causes listed below:

- the BPF or its harmonics may correspond to an acoustic resonance in the ductwork;
- inlet flow distortions;
- unstable, turbulent or swirling inlet flow; and
- operation of an inlet volume control damper.

Fan noise in duct systems can be minimised by avoiding the conditions listed above by ensuring the following:

- sizing ductwork and duct elements for low air velocities
- avoiding abrupt changes in duct cross-sectional area or direction and providing smooth airflow through all duct elements;
- providing 5 to 10 duct diameters of straight ductwork between duct elements;
- using variable speed fans instead of dampers for flow control; and
- if dampers are used, locating them a minimum of 3 (preferably 5 to 10) duct diameters away from room air devices.

11.3 AIR COMPRESSORS

11.3.1 Small Compressors

Air compressors are a common type of noise source. The procedures are presented for small to medium size thermostatically controlled compressors in the range shown, to estimate a conservative sound power level; that is, a

Table 11.4 Estimated sound power levels

Octave band centre frequency (Hz)
31.5
63
125
250
500
1000
2000
4000
8000

Data from Army, Air Force and Navy, USA (1983a).

11.3.2 Large Compressors

The following equations are used to estimate the sound power level within the exit piping of a compressor (Heitner, 1968).

11.3.2.1 Centrifugal Compressors

The overall sound power level is given by

$$L_w = 20 \log_{10} kW$$

where U is the impeller tip speed (m/s) and T is the driver motor (in kW). The

Appendix B
Pure Tone Analysis

Table B-1: Pure Tone Evaluation Continuous Daytime Sound Levels (6 am to 7 pm)

Receptor	Sound Level	Sound Pressure Level (dB) at Octave Band Center Frequency (Hz)									Overall Sound Pressure Level, dBA
		31.5	63	125	250	500	1000	2000	4000	8000	
R East1	Facility Only	51.4	49.8	41.3	29.6	24.7	30.7	23.4	8.8	-30.5	33.7
	Ambient	48.5	46.4	41.6	38.4	35.4	36.2	27.3	13.3	10.9	39.4
	Total	53.2	51.4	44.5	38.9	35.7	37.3	28.8	14.6	10.9	40.4
R East2	Facility Only	52.2	50.5	43.2	31.3	26.4	22.6	17.0	9.0	-22.6	31.6
	Ambient	47.4	45.1	39.9	37.7	34.8	36.3	27.7	14.6	11.4	39.3
	Total	53.5	51.6	44.9	38.6	35.4	36.5	28.1	15.6	11.4	40.0
R South	Facility Only	53.2	51.3	47.2	43.6	40.4	40.3	33.3	23.9	3.6	43.8
	Ambient	48.6	47.1	41.8	35.3	31.6	32.2	26.5	18.1	11.6	36.3
	Total	54.5	52.7	48.3	44.2	40.9	40.9	34.1	24.9	12.3	44.5
R West	Facility Only	53.5	53.2	45.5	41.0	37.9	39.4	31.1	20.8	-8.1	42.2
	Ambient	48.0	43.6	39.3	34.4	30.4	28.0	18.1	12.0	11.4	33.3
	Total	54.6	53.7	46.4	41.9	38.6	39.7	31.3	21.3	11.4	42.7
R North	Facility Only	52.4	51.5	42.0	34.8	30.5	28.8	19.3	6.6	-20.0	34.1
	Ambient	51.9	49.3	41.8	34.4	33.7	32.1	23.9	15.3	12.1	36.7
	Total	55.2	53.5	44.9	37.6	35.4	33.8	25.2	15.8	12.1	38.6
Nearest Inhabited Building	Facility Only	50.4	46.7	41.7	29.5	24.8	21.2	18.9	8.4	-16.5	30.0
	Ambient	48.6	47.1	41.8	35.3	31.6	32.2	26.5	18.1	11.6	36.3
	Total	52.6	49.9	44.7	36.3	32.4	32.6	27.2	18.6	11.6	37.2

Table B-2: Pure Tone Evaluation Continuous Nighttime Sound Levels (7 pm to 6 am)

Receptor	Sound Level	Sound Pressure Level (dB) at Octave Band Center Frequency (Hz)									Overall Sound Pressure Level, dBA
		31.5	63	125	250	500	1000	2000	4000	8000	
R East1	Facility Only	51.7	49.7	41.2	29.1	24.1	20.0	13.5	4.4	-28.7	29.7
	Ambient	46.6	40.8	36.2	35.1	31.6	26.5	15.9	10.3	10.3	33.5
	Total	52.9	50.2	42.4	36.1	32.3	27.4	17.9	11.3	10.3	35.0
R East2	Facility Only	52.3	50.3	43.1	31.0	26.0	21.4	16.3	8.8	-22.5	31.3
	Ambient	47.6	42.1	35.3	33.0	29.6	28.1	17.2	10.0	10.4	32.4
	Total	53.6	50.9	43.8	35.1	31.2	29.0	19.8	12.4	10.4	34.9
R South	Facility Only	59.6	58.9	42.5	34.5	29.0	23.3	13.3	2.8	14.6	35.4
	Ambient	46.3	44.9	39.3	32.9	28.4	27.9	24.1	16.6	11.8	33.4
	Total	59.8	59.1	44.2	36.8	31.7	29.2	24.5	16.8	16.4	37.5
R West	Facility Only	60.2	60.4	39.2	31.7	26.3	21.6	8.6	-4.5	3.4	35.5
	Ambient	43.2	38.9	35.8	33.2	27.6	23.9	15.8	12.2	11.8	30.6
	Total	60.3	60.4	40.8	35.5	30.0	25.9	16.5	12.3	12.4	36.7
R North	Facility Only	53.4	52.7	40.8	28.9	24.1	19.1	12.1	-0.6	-17.6	30.4
	Ambient	45.7	47.7	39.4	31.7	31.0	26.7	19.2	13.6	11.7	33.0
	Total	54.1	53.9	43.2	33.5	31.8	27.4	20.0	13.8	11.7	34.9
Nearest Inhabited Building	Facility Only	51.8	48.2	41.6	28.8	24.0	19.2	14.2	4.7	-12.8	29.4
	Ambient	46.3	44.9	39.3	32.9	28.4	27.9	24.1	16.6	11.8	33.4
	Total	52.9	49.9	43.6	34.3	29.7	28.4	24.5	16.9	11.8	34.9